



PROGRAM DESCRIPTION "MCC-MT"

2023

Table of contents

Introduction	3
1 Running a program	5
2 The structure of the program and its elements	5
2.1 Main window of the program	5
2.2 Main toolbar	6
2.3 Work with elements	9
3 Tools for constructing a geometric model	11
3.1 Surface Cylinder	13
3.2 Surface Rotation figure	13
3.3 Surface Cone	18
3.4 Surface Sphere	18
3.5 Surface Torus	19
3.6 Surface Shift figure	21
3.7 Surface Parallelepiped	21
3.8 Surface Triangle	22
3.9 Surface Rectangle	23
3.10 Surface Polygon	23
3.11 Surface Disc	24
3.12 Working with elements	25
4 Calculation part	26
4.1 Item Elements	27
4.2 Item Radiation source geometry	29
4.3 Item Radiation type	30
4.4 Item Measuring mode	31
4.5 Item Calculation parameters	34
4.6 Item Materials	36
4.7 Item Radiation Sources	38
4.8 Formats of source files	39
5 Draw settings	42
6 Spectrum mapping module	44
7 Example of the project creation	55
8 Example of the efficiency curve creation	64
8.1 Efficiency curve creation based on artificial monoenergetic lines	64
8.2 Efficiency curve creation based on sources with multiple energy lines	68

Introduction

This manual is intended to describe the operating principle, capabilities and structure of software "MCC-MT".

Software "MCC-MT" – is a program of simulation of three-dimensional modeling of the processes of transfer and registration of ionizing radiation. This program allows you to solve the task of calculating the response function of the detector solely on the basis of a developed graphical interface (without using programming in algorithmic languages). In particular, it provides an opportunity to create a detailed complex geometric model of the developed detection device, perform calculations and obtain results in the required form.

The program "MCC-MT" makes it possible to calculate the response function for detectors most often used in the field of radiation monitoring irradiated with photon sources, electrons (positrons) in the energy range from 1 keV to 10 MeV. The program is supplied with reference materials and means of information protection.

The software "MCC-MT" makes it possible, using modern methods of calculation of radiation transfer through a substance, to simplify considerably the solution of practical problems in the development, optimization and calibration of a wide variety of ionizing radiation detection systems.

"MCC-MT" provides the solution of the following tasks:

- acceleration and simplification of design and optimization of ionizing radiation detection systems;
- improvement of technical characteristics of these systems, widening the ranges of their application; reduction of time and expense of budget funds for their design;
- reduction of experimental research using hazardous ionizing radiation for human health;
- reception of characteristics of the registration system for radioactive sources that are inaccessible in normal practice;
- obtaining an intuitive picture of the internal processes of radiation transfer, which makes it possible to optimize the design of the measuring device and its protection;
- implementation of the comparative demonstration of various protection systems against ionizing radiation, as well as its detection systems for advertising purposes;
- training of personnel to work with registration systems of ionizing radiation without the use of expensive equipment and radioactive sources;
- training of specialists in the field of measurement and protection against ionizing radiation.

The main feature of this software product is the combination of accuracy of results with ease of operation and wide availability for solving practical problems. Its application makes it possible to optimize and improve the parameters of a wide variety of radiation detection devices used in the nuclear industry and radiation monitoring systems of the environment.

One of the important features of the software "MCC-MT" is a developed user interface that allows an operator familiar with working in the Windows operating environment to create complex three-dimensional geometric objects. The user can assign to these objects the properties of the corresponding materials, identify objects that are endowed with the properties of detectors, set the necessary exposure, connect various sources of radiation, including taking into account cascade processes. The calculated data are formed in the form of energy spectra absorbed by a particular detector and can be easily converted into a response function of the detector with its energy resolution using a special software module.

The MCC-MT program allows the user to create geometric models using a set of graphical primitives.

The program saves complete information about the geometry of the experiment and calculation parameters in special files with an internal format and has an extension **.mcp*.

System requirements:

- Windows XP/Vista/7/8/10;
- processor with a frequency of 1 GHz;
- NVIDIA graphics card (recommended);
- 100 MB of free hard disk space;
- keyboard;
- mouse.

1 Running a program

The program "MCC-MT" starts by double-clicking the left mouse button on the icon "MCC-MT" on the Windows desktop.



2 The structure of the program and its elements

2.1 Main window of the program

After loading the program, the main working window of the program appears on the screen (Fig. 1).

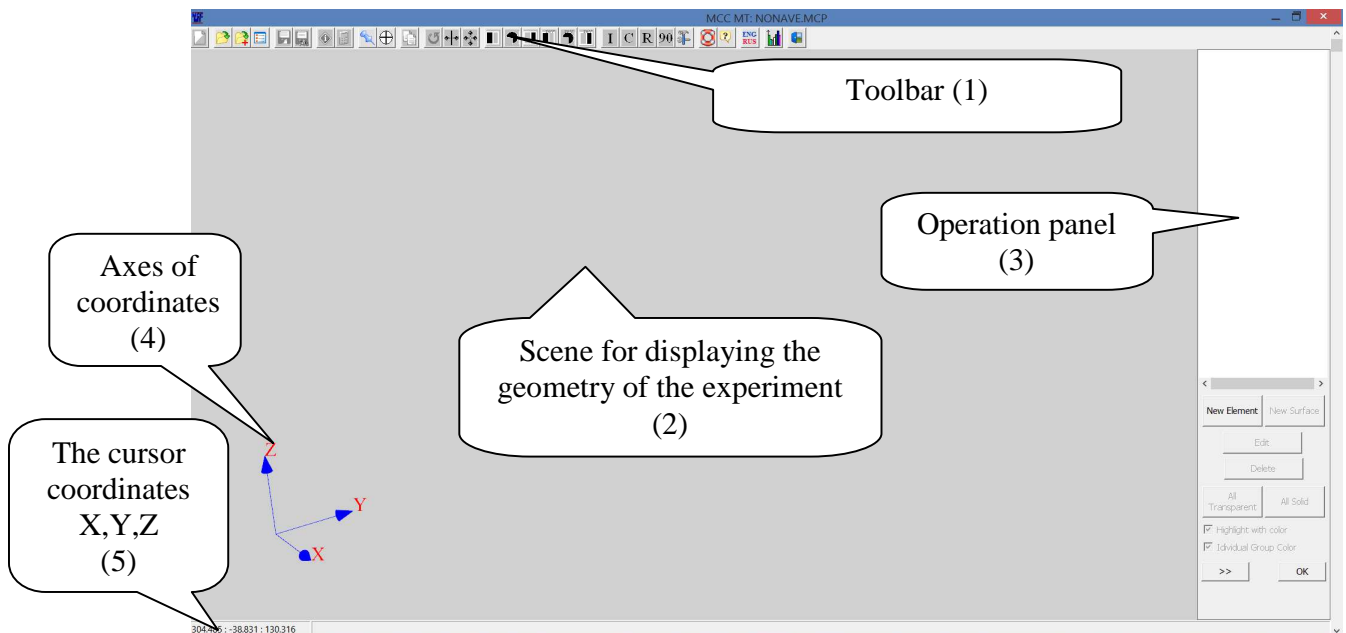



Figure 1. View of software "MCC-MT" after startup

The program window contains four main blocks:

- a scene for displaying the geometry of the experiment - the space for displaying the user-created geometry and the particle trajectory (block 2);
- main toolbar, containing buttons that provide access to the main functions (Block 1);
- the work panel with elements - the area of the working window of the program, containing tools that allow you to add or remove elements of geometry, as well as form the view of these elements (block 3);
- coordinates of the cursor - the status field for displaying the current coordinates of the cursor in a three-dimensional Cartesian coordinate system (X: Y: Z) cm (block 5). It is also possible to display coordinate axes either in the corner of the graphic area or at the origin.

 - top view. Change the view to the scene in the graphics area in the projection to the XY plane.



- side view. Changing the scene view in the graphics area in projection to the ZX plane.



- back view. Changing the scene view in the graphics area in projection to the YZ plane from the reverse side.



- bottom view. Changing the scene view in the graphics area in projection to the XY plane from the reverse side.



- reverse side view. Changing the view to the scene in the graphics area in the projection on the ZX plane from the reverse side.



- isometry projection. A view of the scene in the graphic area in the isometric view. As an example, the image of the detector in the protective chamber is shown in isometric projection (Fig. 3).

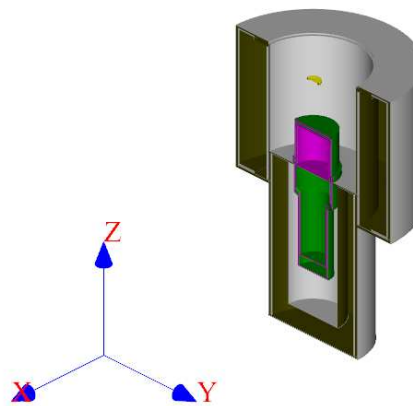

Figure 3. Isometric projection



- cabinet projection. A view of the scene in the graphic area in the 'cabinet' projection. As an example, the image of the detector in the protective chamber in the 'cabinet' projection is shown (Fig. 4).

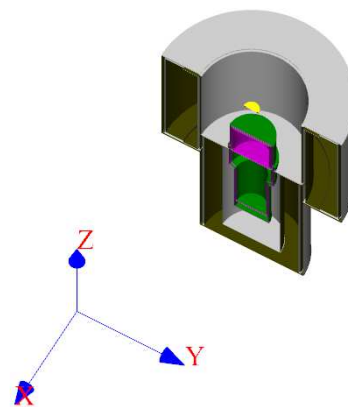



Figure 4. "Cabinet" projection

 - turn over. Changing the view to the scene in the graphics area by 180 degrees, that is, reversing the observation point behind the scene.

 - turn through -90° . Change the view to the scene in the graphics area for 90 degrees, that is, the rotation of the observation point behind the scene. As an example, the image of the detector in the protective chamber is shown before and after the program executes this command.

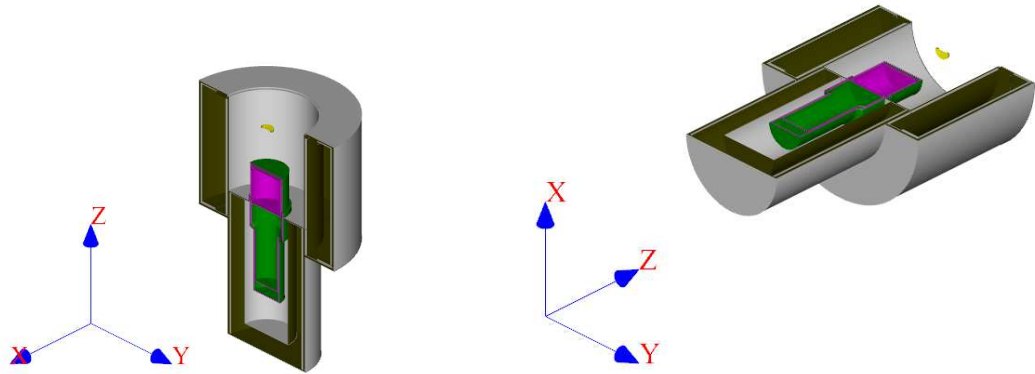





Figure 5. Rotate the view to the scene 90 degrees before and after

 - view properties. Opens a dialog box containing tools for customizing the color and appearance of the elements and surfaces that make up the geometry of the experiment, as well as customizing the program interface (see Section 5).

 - button for changing the language of the program "MCC-MT".

 - call the program module "MCC Viewer", which allows you to view and perform operations on the spectra obtained in the experiment simulation (see. Section 6).

 - completion of the program "MCC-MT".

2.3 Work with elements

The work with elements panel is used to create and edit a geometric model of an experiment.

The panel has two tabs, switching between which is carried out by pressing the button (Fig.6).

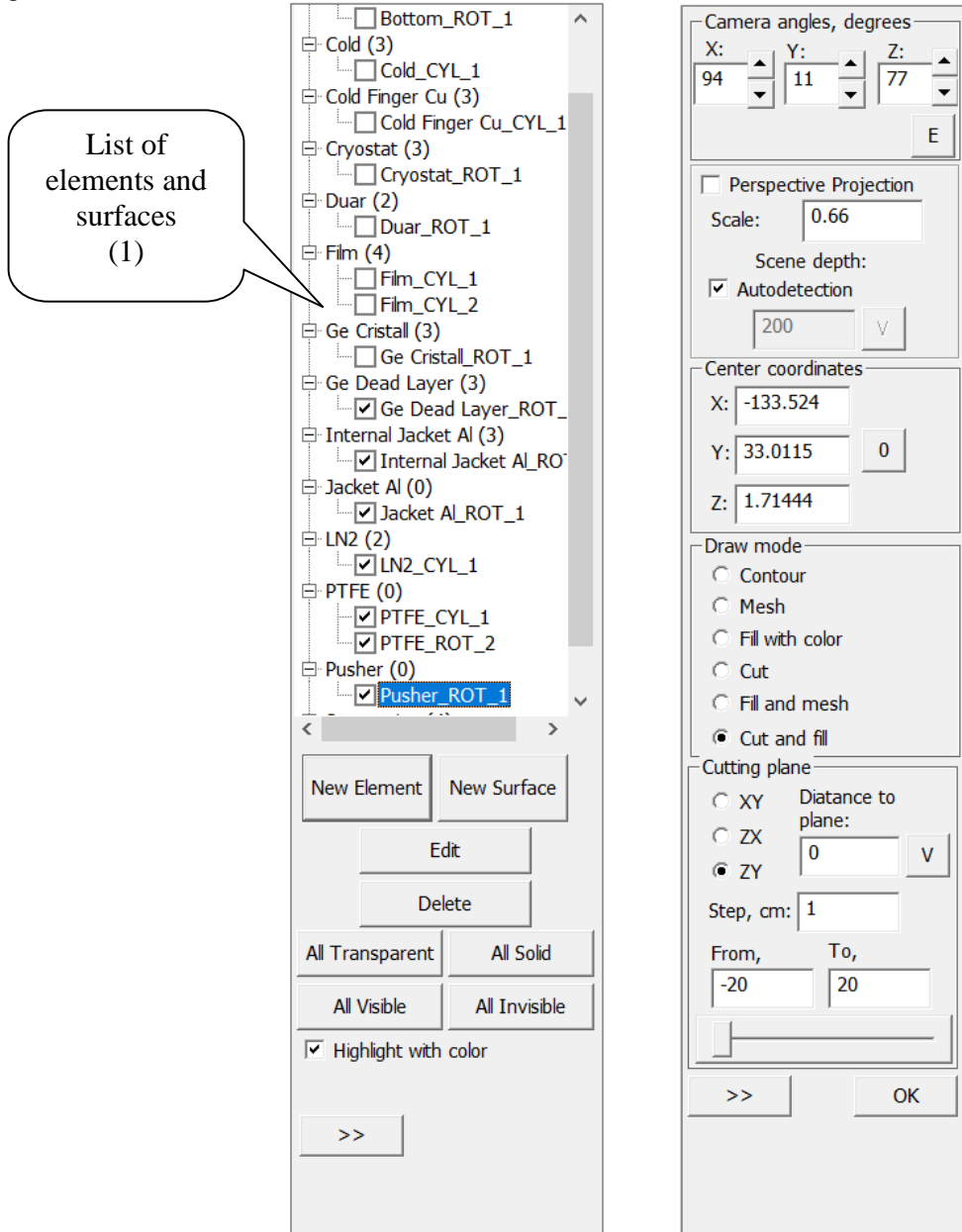

Figure 6. View of the panel of work with elements

The panel contains the following component buttons:

List of elements and surfaces (Fig.6, block 1) – contains a list of the names of the elements and their constituent surfaces, which together determine the content of the current project. Control access to the parameters of each surface in the element can be obtained by double-clicking the left mouse button on the name of the surface. In case you need to hide the surface remove the check mark before the name of this surface.

New Element – button to add a new element to the list of elements.

New Surface - button for adding a new surface to the current element (selected in the list of elements).

Edit – a button to open a dialog box with the parameters of the selected element or surface. For an element, you can change its name and group. Changes in geometric characteristics are available for the surface. A similar action is duplicated by double clicking on the name of an element or surface.

Delete – button to delete the selected element or surface.

All transparent, All solid – button to hide or show all surfaces. Clicking this button repeats the removing the checkmark visibility for each surface in the list of elements.

Highlight with color – indicator for switching the selection mode of the selected element by another color.

Individual group color - indicator for switching the mode of selection of groups of elements by individual color. The color of the corresponding group of elements is indicated in the **Image Settings** window.

Camera angles degree – a group of coordinate parameters that allows you to change the angle of observation behind the scene. By pressing the arrows on the right of the value (X, Y or Z), you can change the angle of observation behind the scene. In this case, the position of the surfaces remains unchanged. The rotation is performed around the corresponding coordinate axis. The **E** button will reset the camera's rotation angles. Only applies to methods of rendering of the form without the section.

Scale - Scene Scale Parameter. The larger the scale, the greater volume of space can be observed. The unit scale corresponds approximately to the real linear dimensions of the surfaces.

Center coordinates - coordinates (X, Y, Z) in the center of the screen. By pressing the **0** button, the point with zero coordinates is returned to the center of the graphics area.

Draw mode – a group of radio buttons that allow you to toggle the type of graphical representation of elements and surfaces on the scene:

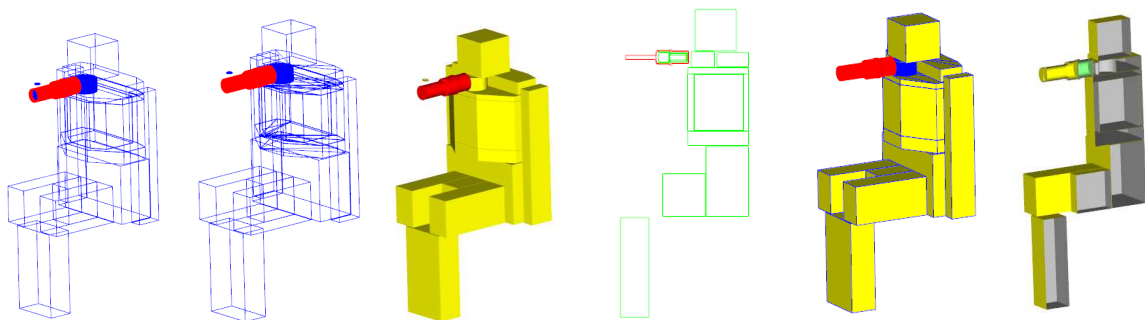

Figure 7. Variants of renders of the constructed model (left to right): **Contour, Mesh, Fill with color, Cut, Fill and mesh, Cut and fill**

Cutting plane – group of parameters defining the characteristics of the section view (cut plane, the displacement of the cut plane, step of displacement). This group appears only for the **Cut** and **Cut and fill** types.

3 Tools for constructing a geometric model

The main stage of work with the program "MCC-MT" is the creation of geometric shapes, from which consist the models of the detector, the source and the environment.

To create an element of modeling geometry, click on the **New element** button located on the **Panel of work with elements** (Fig. 6) on the right side of the main program window.

It should be noted that the element can be either a single geometric figure or a set of them, then these same geometric figures constituting the structural element will be assigned the same parameters (chemical composition, properties).

The main rules for building a set of elements:

- surfaces should not intersect (i.e. there should be a gap between all surfaces);
- it is necessary to check of the normal direction so that the substance (inner space) is always closed in a certain volume. In other words, any object (element) must be closed on all sides. The normals of all surfaces of each element must be directed inside the element.

After clicking on the **New element** button the window **Element** should appear (see Fig.8):

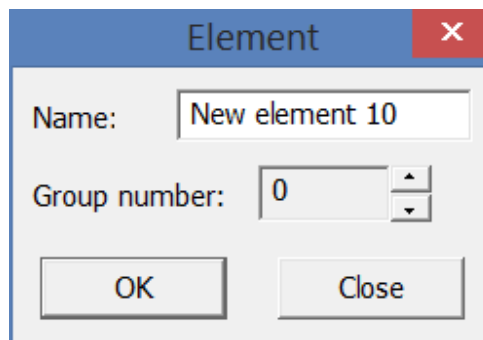

Figure 8

In the dialog box that appears, you must enter the name of the new element and the number of the group to which the element should belong (if necessary). After pressing the **OK** button in the list of elements (see Fig. 6, block 1) a line with the new element name should appear, and a new dialog box will appear immediately, in which the user must select the surface type (primitive) (Fig.9).

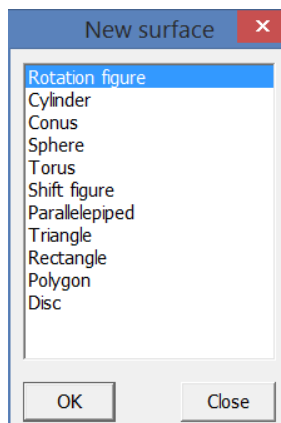

Figure 9. The surface selection window for an element

The user needs to choose one of the following options: **Rotation figure, Cylinder, Cone, Sphere, Torus, Shift figure, Parallelepiped, Triangle, Rectangle, Polygon, Disc**. To do this, double-click the selected surface type with the left mouse button or select it and click **OK**.

After the user chooses a geometric primitive from the list, opens a dialog box containing parameters specific to the type.

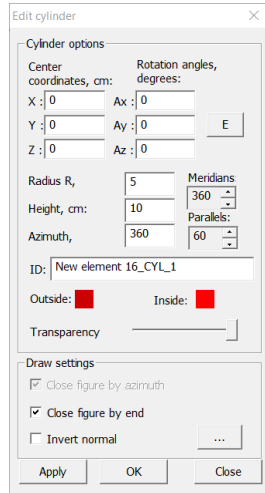

Figure 10. Shape options window **Cylinder**

A part of the properties is common for all figures - these are the coordinates of the center of the figure and the angles of rotation relative to the corresponding coordinate axes. Pressing the button **E** (see. Fig. 10) located near the rotation angles values leads to zeroing figure rotation matrix.

Checking the **Invert normal** box allows you to change the direction of the normal of surface. This means that if the checkbox is not checked (the normal is not inverted), then the substance (the body of the figure) is enclosed within the boundaries of the surface of this figure, and there is no substance around the figure. And vice versa, the checked tick means for this figure that the boundaries of its surface allocate an empty volume of space in the substance. In this case, one more figure will be required for limit the space by another surface. For a correct calculation, all elements must be closed on all sides.

The presence of the field **Close figure by end** allows you to make the figure closed. By checking this box, the shape becomes closed. If this check box is cleared, the shape should be closed by other elements (for example, **Disc**).

Button "... " (see Fig.10) is designed to set vertical holes, which make it easy to form collimators of any kind. A similar button is present for other types of figures (available for **Cylinder, Cone, Shift figure, Parallelepiped**). Pressing this button opens a window **Collimators** as shown in the figure 10.1.

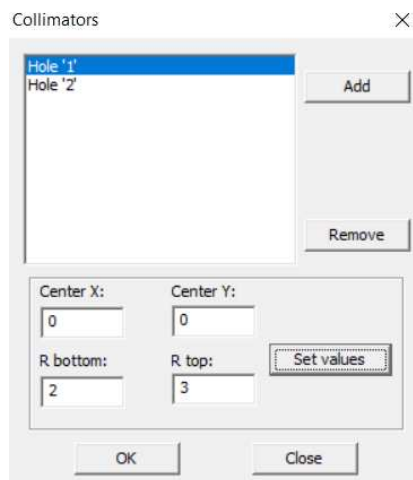

Figure 10.1 Window **Collimators**

The transparency indicator, as well as colored squares, allows you to set the transparency and color (inner and outer) for each shape individually. To change the color, double-click on the color, after which the color selection dialog box will open.

The **Apply** button allows you to apply the changes made without closing the parameter editing window and evaluate the result of the changes. If all the parameters match your plan, click the **Close** button.

3.1 Surface Cylinder

As individual parameters of the surface **Cylinder**, the **Radius**, **Height** (in centimeters) and **Azimuth** (in degrees) are given (see Fig.10). The azimuth parameter allows you to cut a sector from the cylinder as shown in Figure 11.

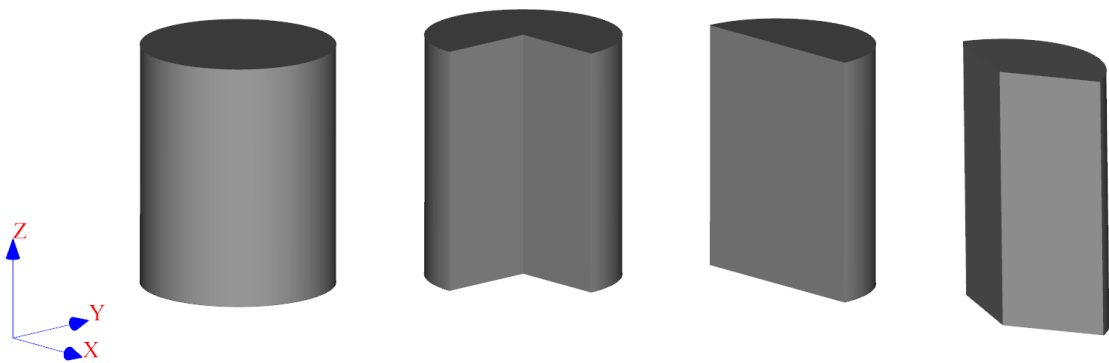

Figure 11. Cylinder with Azimuth 360°, 270°, 180°, 135°

3.2 Surface Rotation figure

To add a Rotation figure, you must select the type of the **Rotation figure** in the surface selection window (see Fig.9).

The parameters of the rotation figure include (see Fig. 12) arbitrary values of the coordinates of the rotation contour in a cylindrical coordinate system in a certain plane (Z cm, R cm), that is, at an altitude Z the radius of the rotation figure will be R cm (greater than zero). Thus, it is possible to describe an arbitrarily complex rotation figure. The Azimuth is the angle of the matrix of the rotation figure. In the edit box Coordinate coordinates, enter the coordinates of the nodes of the rotation figure separated by a "space" following the given example.

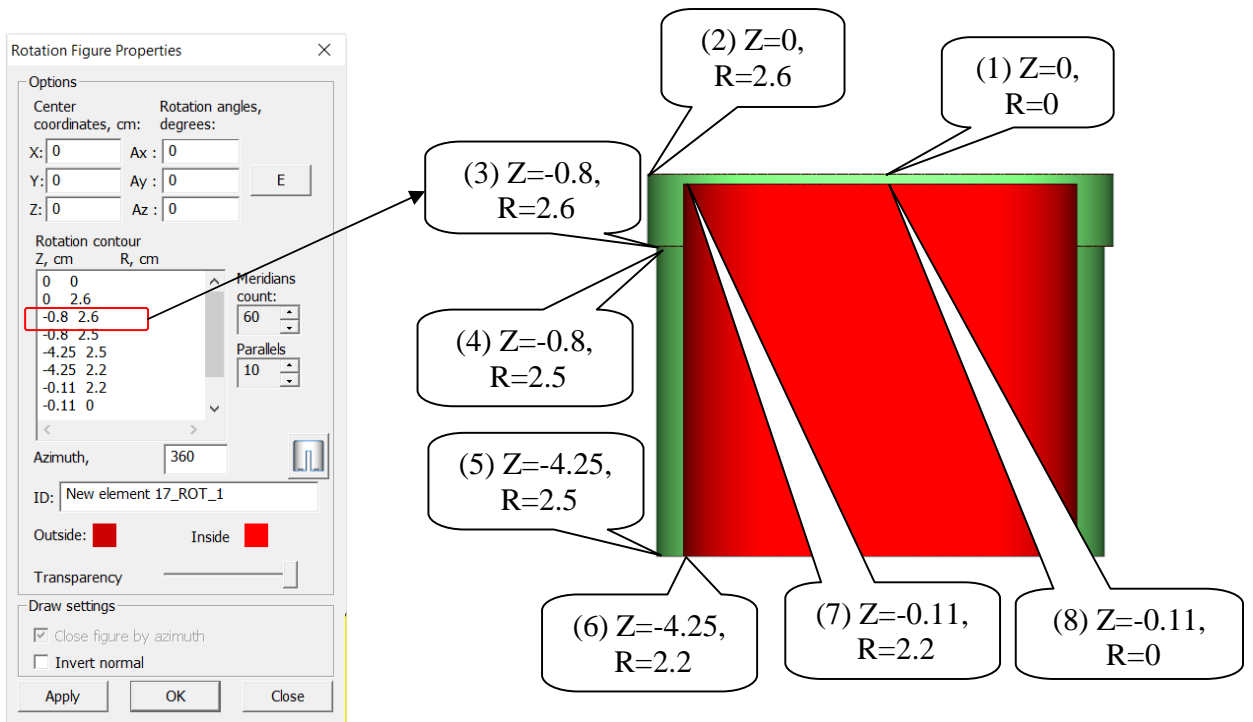

Figure 12. Forming a **Rotation figure**

Figure 13 shows a Rotation figure constructed in accordance with the example (Fig. 12) in a section and in different isometric projections.

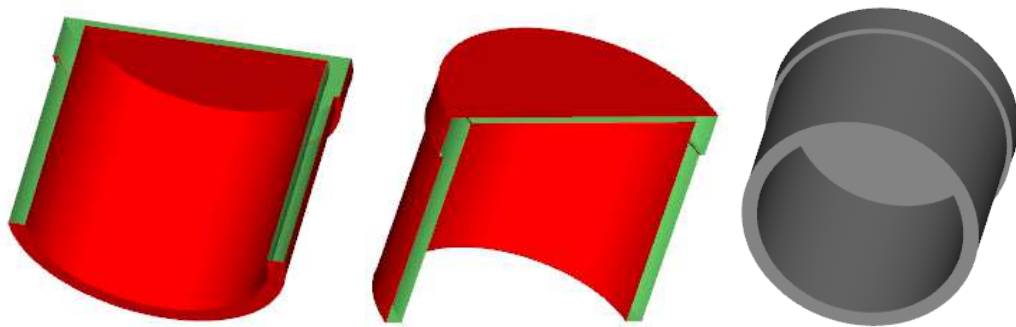

Figure 13. Kinds of Rotation figure

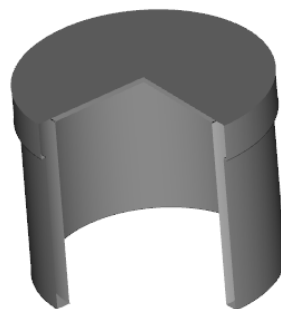

Figure 13.1. Rotation figures with the Azimuth equal to 270°

In applied spectrometry, one of the most common tasks is to determine the response from a coaxial HPGe detector. For convenient and quick construction of the figure of such detector, a special tool is implemented in the "MCC-MT" software.

To perform such construction it is necessary to add the rotation figure "Ge crystal" (the name of the figure as an example) (working volume of a germanium crystal) to the list of elements, and then the rotation figure "Ge Dead Layer" ('dead layer' of a germanium crystal) (see Fig. 13.2).

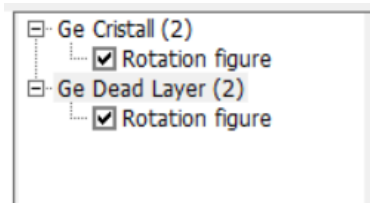

Figure 13.2

Next, you should open the parameters window for the rotation figure (see Figure 13.3). Initially, some default values will be shown in the list of contour coordinates. To go to the tool for constructing a detector press the button



(Fig. 13.3, block 1).

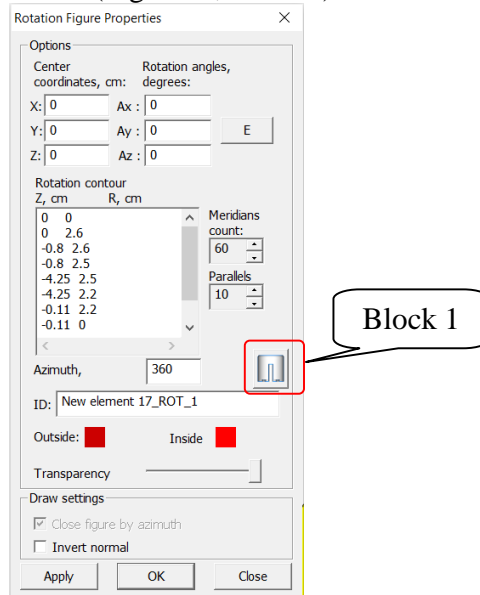

Figure 13.3

Next the dialog window of the **Characterization.Coordinates of detector maker.** module will appear on the screen (see Figure 13.4).

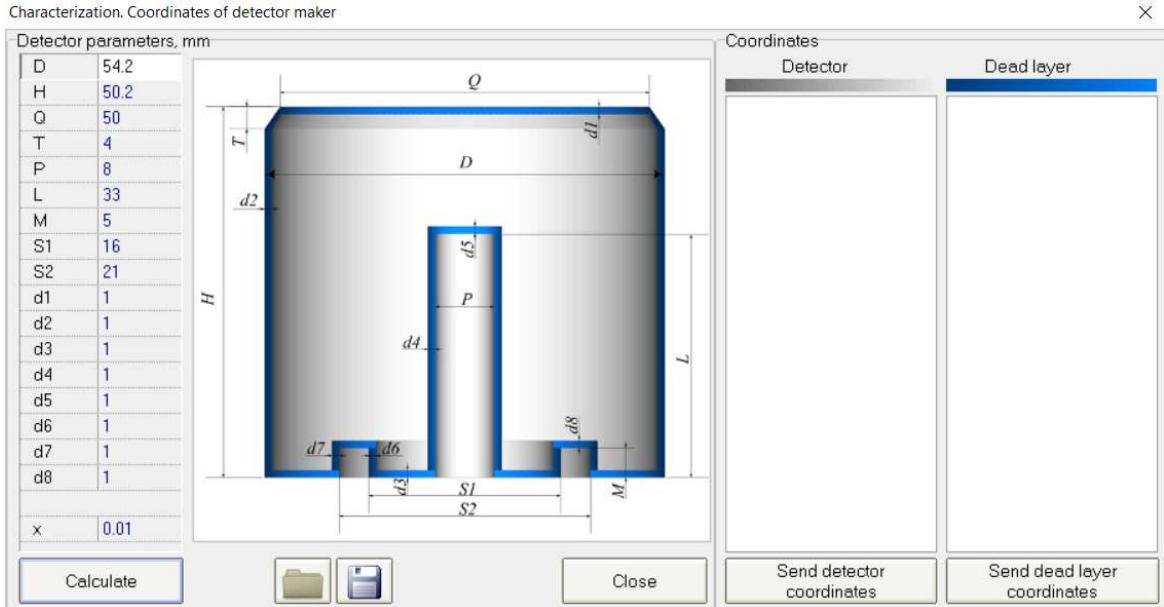

Figure 13.4 Window **Characterization. Coordinates of detector maker**

In this window in the fields **Detector parameters**, enter the geometric data of the detector provided by the manufacturer. After that, press the **Calculate** button, after which the calculated coordinates for constructing the surfaces of the rotation figures of the detector and its dead layer will appear in the two columns **Detector** and **Dead layer** located on the right (see Fig. 13.5).

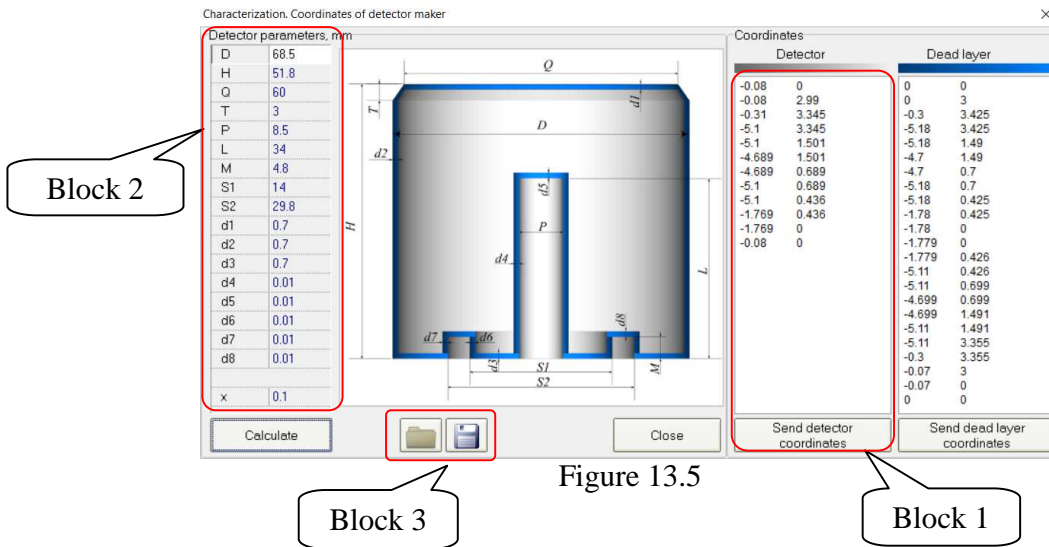

Figure 13.5

Further, depending on which figure is selected for construction (detector or dead layer), you need press the button **Send detector coordinates** or **Send dead layer coordinates**, respectively. After that, in the field of coordinates of the contour of the selected rotation, the coordinates calculated in the module will appear (see figure 13.5, block 1 and figure 13.6, block 1).

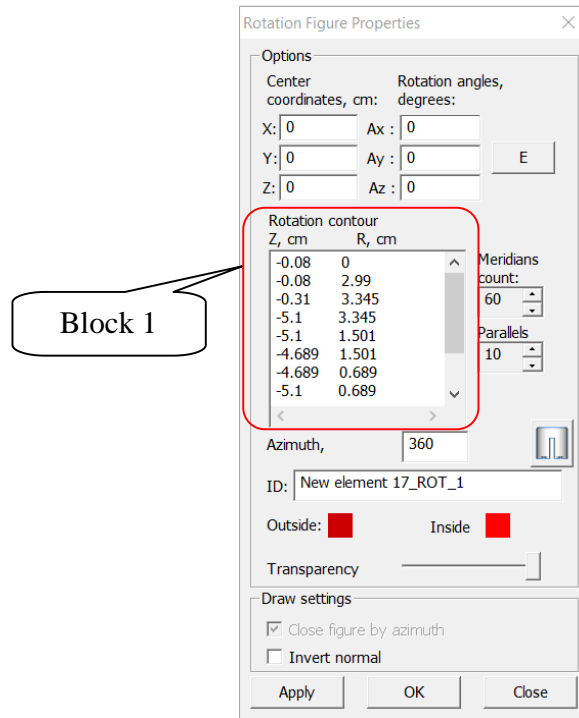

Figure 13.6

Similarly, the procedure must be repeated for the figure of the dead layer of the detector. As a result, a ready-made set of two elements describing a germanium detector will appear on the scene (see Fig. 13.7).

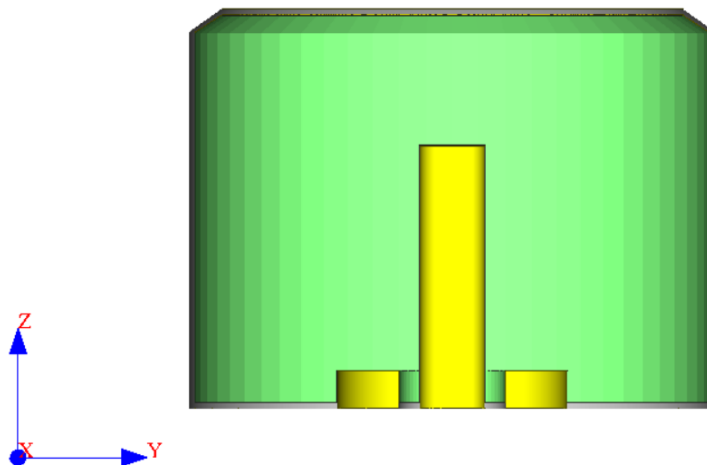



Figure 13.7 Result of construction the model of detector using the tool **Characterization. Coordinates of detector maker**

It should be noted that the **Characterization. Coordinates of detector maker** module is just a tool for calculating the coordinates of the detector surface. The geometrical dimensions of the detector in the module fields (Fig. 13.5, block 2) are not stored in the **.mcp* project file. If you need to save this data, you should use the buttons   (Fig. 13.5, block 3) to save and open a file with the geometric parameters of the detector.

3.3 Surface Cone

The cone parameters include 3 values in the proper cylindrical coordinate system of the cone: radius of the first base Radius R1 and radius of the second base Radius R2 (if both radii are not equal to zero - we get a truncated cone) and the height of the cone.

Parameter **Azimuth** allows you to draw a fraction of the cone as shown on the Figures 14.1,14.2.

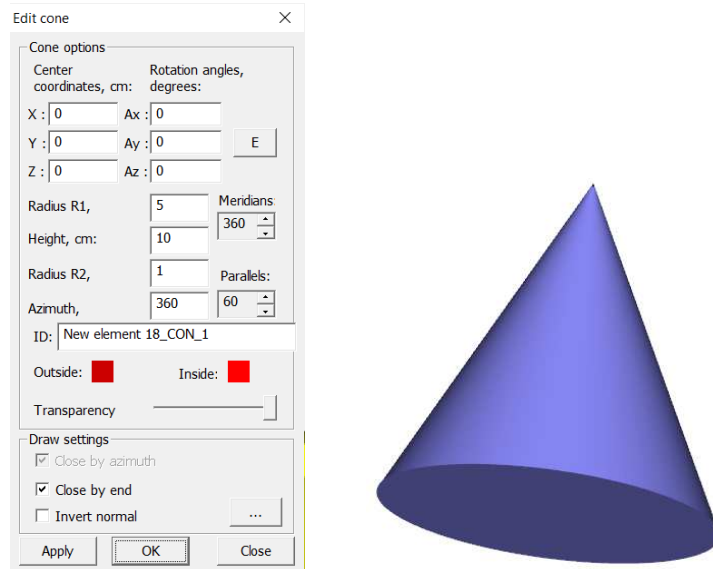

Figure 14.1. Surface Cone

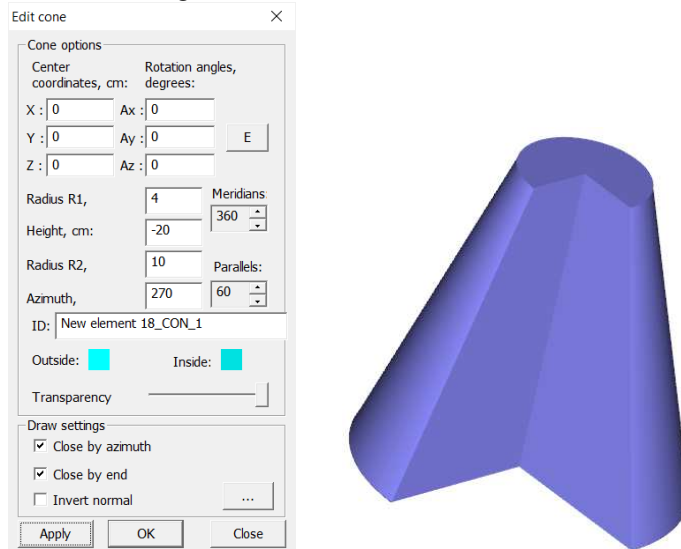

Figure 14.2. The surface of a truncated Cone, the azimuth is equal 270

3.4 Surface Sphere

The parameters of the **Sphere** include **Radius** (R, cm), **Azimuth angle** (0-180) and **Azimuth** (see Fig.15.1). The **Azimuth** angle allows you to represent the truncation of the sphere as shown on Figure 15.2.

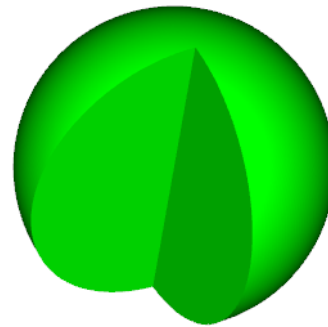
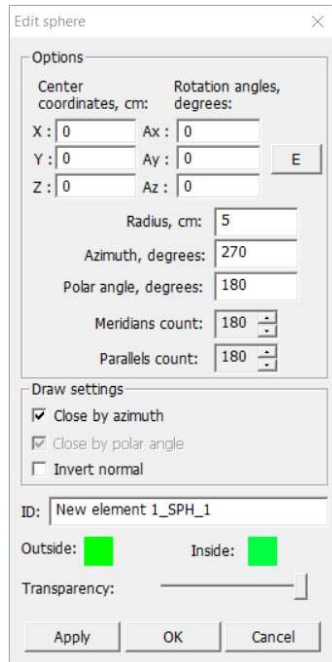

Figure 15.1. Surface **Sphere**, Azimuth 270, Azimuth angle 180

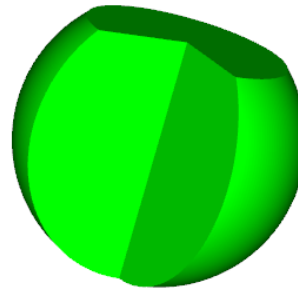
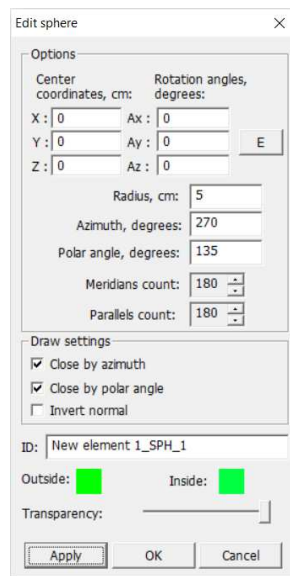

Figure 15.2. Surface **Sphere**, Azimuth 270, Azimuth angle 135

3.5 Surface Torus

The parameters of the **Torus** include the **External radius** and the **Internal radius**, the **External azimuth** (0-360 degrees), and the **Internal azimuth** (0-360 degrees) (see Fig. 16.1). In this case, the **External azimuth** is the apex angle of the torus solution, and the **Internal azimuth** allows to extract the sector in the section of the ring of the volume-forming torus (see Fig. 16.2).

There are also two additional parameters: **Close by external azimuth** and **Close by internal azimuth**, which allow creating an open figure (if at least one of the check marks is removed). In this

case, it is necessary to close the surface with another figure, for example a polygon or a figure of rotation.

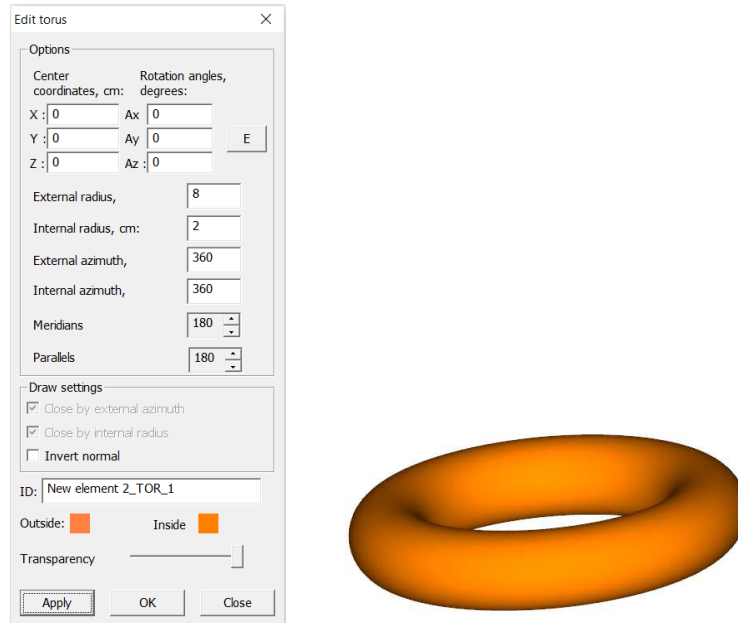

Figure 16.1. Surface **Torus**, External azimuth 360, Internal azimuth 360

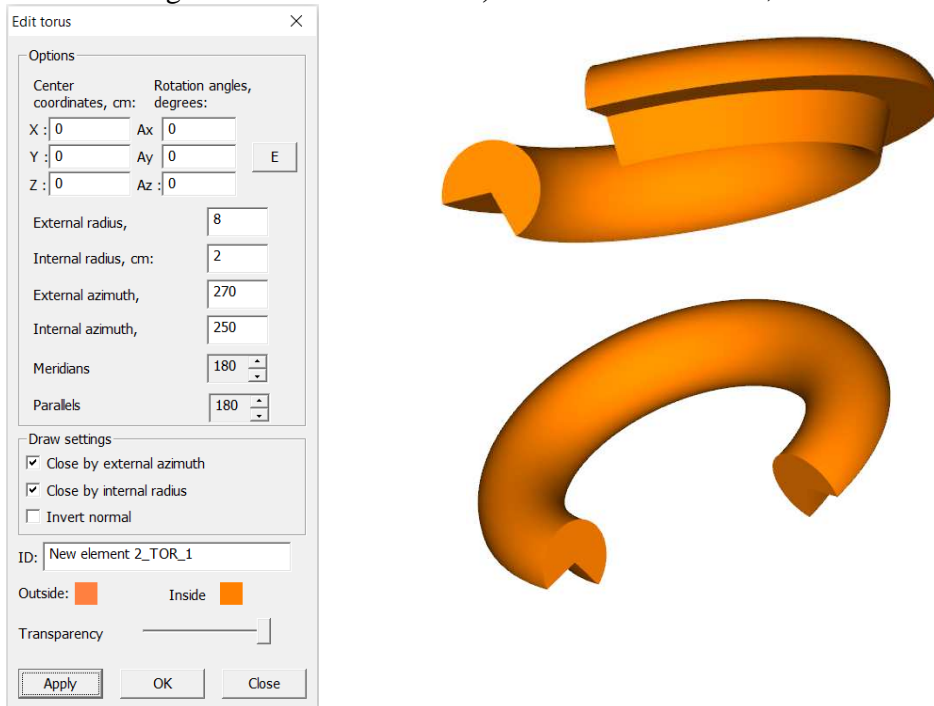

Figure 16.2. Surface **Torus**, External azimuth 270, Internal azimuth 250

3.6 Surface Shift figure

Surface **Shift figure** is a kind of cylinder with an arbitrary (in the form of a polygon) base, which can be made arbitrarily complex by defining the points of this base in the (X, Y) plane in the **Contour coordinates** field (see Fig. 17). But the **Shift figure** creates the walls of such a "cylinder". Figure 17 shows an example of how to use the **Shape of Shift**.

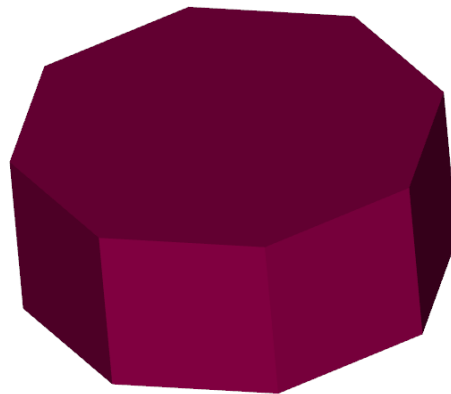
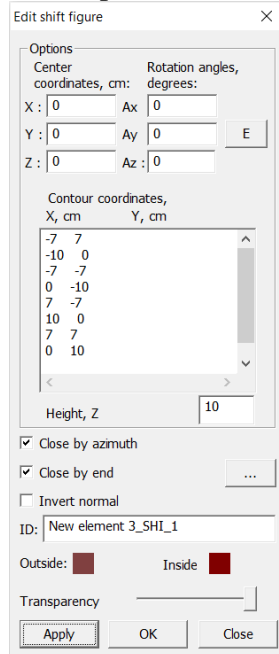

Figure 17. Surface **Shift figure**

The base on which the walls will be created should be closed, that is, the coordinates of the last point should coincide with the coordinates of the first point (performed automatically) and the bypass should be counterclockwise.

The **Height, Z** is the height of the shape with an arbitrary base on the z-axis.

3.7 Surface Parallelepiped

The **Parallelepiped** surface parameters include the linear dimensions of the parallelepiped **Length X, Width Y** and **Height Z** (cm).

Figure 18 shows an example of the realization on the stage of a figure **Parallelepiped**.

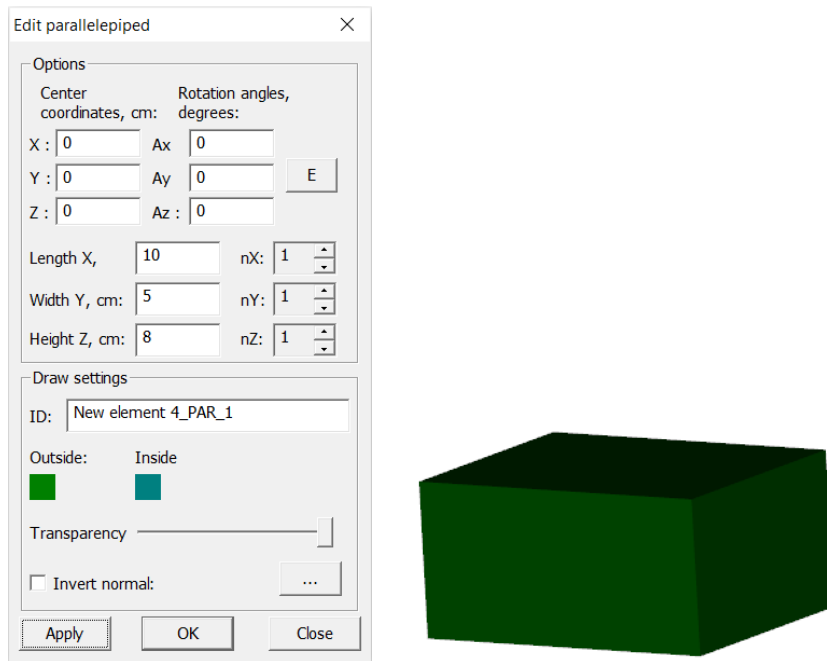

Figure 18. Surface **Parallelepiped**

3.8 Surface Triangle

The triangle parameters include the Z-axis **Height** (H, cm), the first **Base X1** and the second **Base X2** perpendicular to the Z axis. You can also set arbitrary vertices of the triangle to arbitrary values of the coordinates by (X, Y, Z) by clicking the **Set axes** button (see Fig.19).

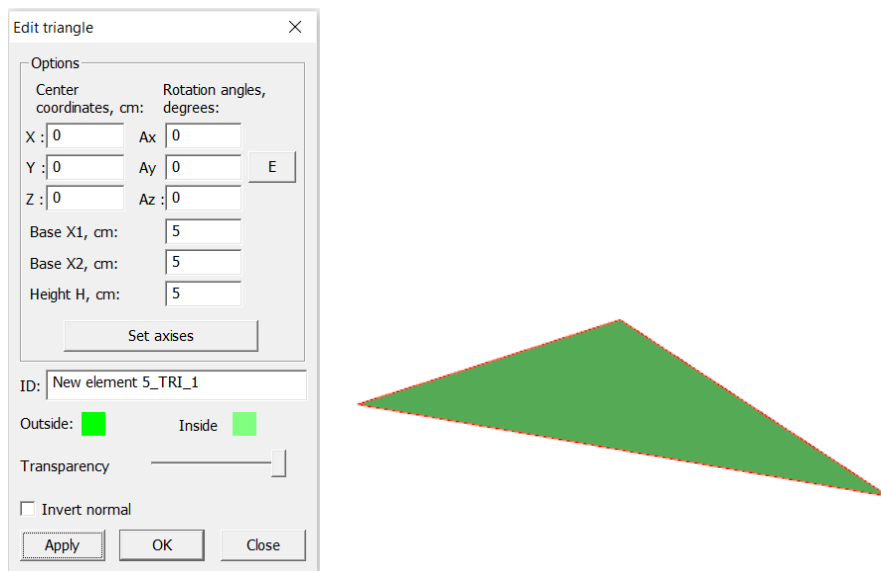

Figure 19. Surface **Triangle**

When creating a **Triangle** surface, one should take into account the fact that one side of the triangle has one direction of the normal (external) and the other side is the inner direction of the normal. Thus, the triangle should be used to close any surfaces.

3.9 Surface Rectangle

The parameters of the rectangle include linear dimensions **Length** and **Width** (see Figure 20)

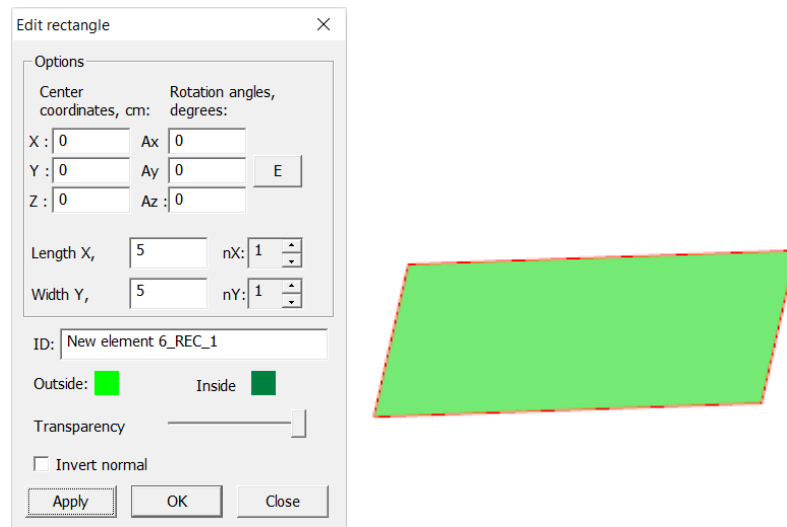

Figure 20. Surface **Rectangle**

When creating a **Rectangle** surface, one should take into account the fact that one side of the rectangle has one direction of the normal (outer) and the other side is the inner direction of the normal. Thus, the rectangle should be used to close any surfaces.

3.10 Surface Polygon

Polygon parameters include arbitrary values of the coordinates of the vertices in (X, Y) given in the **Coordinates** field (see Fig. 21).

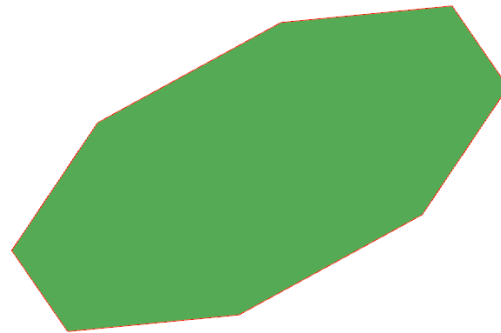
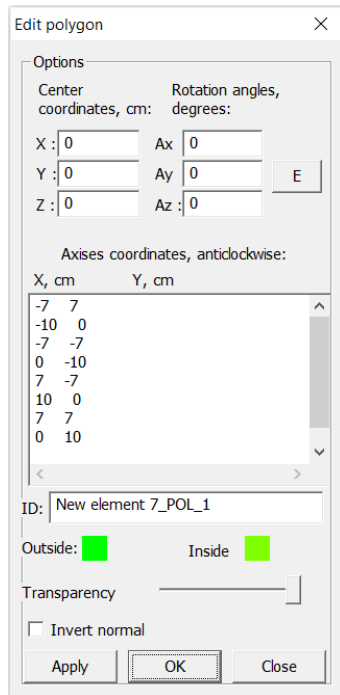

Figure 21. Surface **Polygon**

When creating a **Polygon** surface, one should take into account the fact that one side of the polygon has one direction of the normal (external) and the other side is the inner direction of the normal. Thus, the polygon should be used to close any surfaces.

3.11 Surface Disc

The parameters of the surface **Disc** includes **Internal radius**, **External radius** and **Azimuth**. The **Azimuth** parameter is the apex angle of the figure and allows to form a certain sector (see Fig. 22).

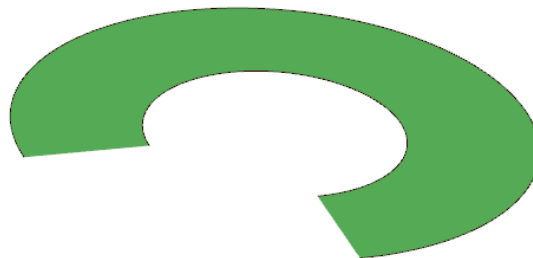
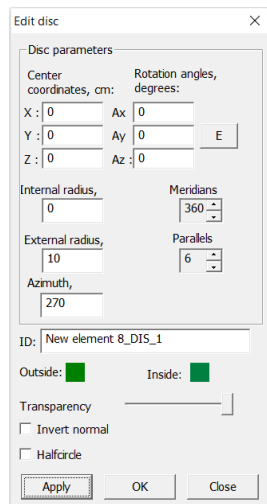





Figure 22. Surface **Disc**, azimuth 270

When creating the surface **Disc**, one should take into account the fact that one side of the polygon has one direction of the normal (external), and the other side is the inner direction of the normal. Thus, the disk should be used to close any surfaces.

3.12 Working with elements

If you need to move or rotate elements, use the buttons  (rotate around axis),  (reflection from plane),  (shift along axis).

So, for example, there are two figures - a cylinder and a truncated cone (see Fig.22.1).

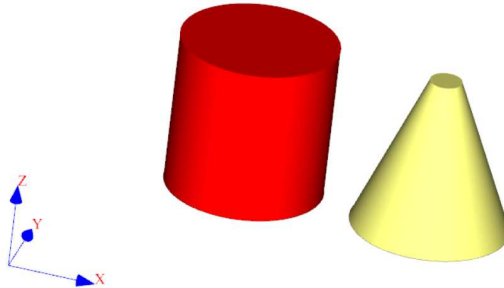



Figure 22.1. The initial position of the figures before moving

To rotate the cylinder around the X axis, select the required element in the toolbar or click the left mouse button twice on the element on the stage. Then press the button  in the toolbar, which brings up a dialog box that allows you to specify the rotation parameters (see Fig.22.2).

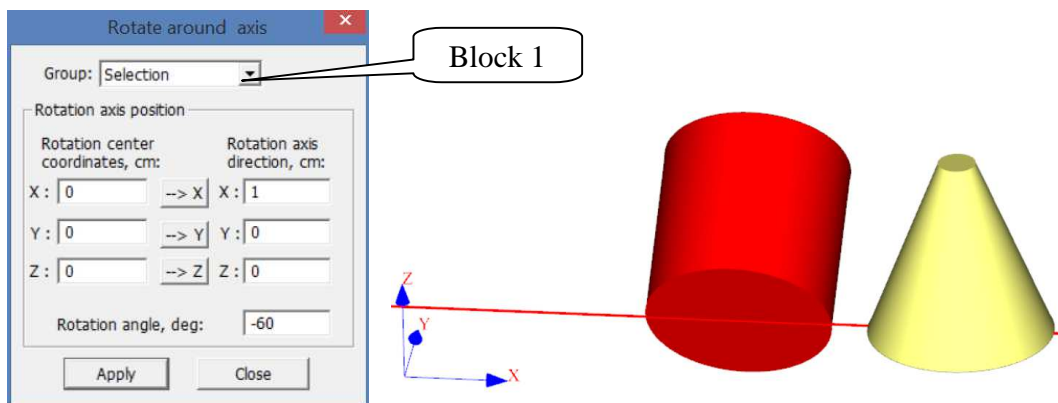



Figure 22.2. Window **Rotate around axis** and the shape of the modified position of the figure

In this window, specify the rotation angle in the **Rotation angle** field and set 1 in the **Rotation axis direction** field for the corresponding axis. Then click the **Apply** button.

If necessary, perform a mirror image on an axis in the same way, select the element in the toolbar and press the button . After that appears the dialog box **Reflect from plane** (see Fig.22.3). By selecting the corresponding rotation axis and clicking the **Apply** button, the shape will be rotated.

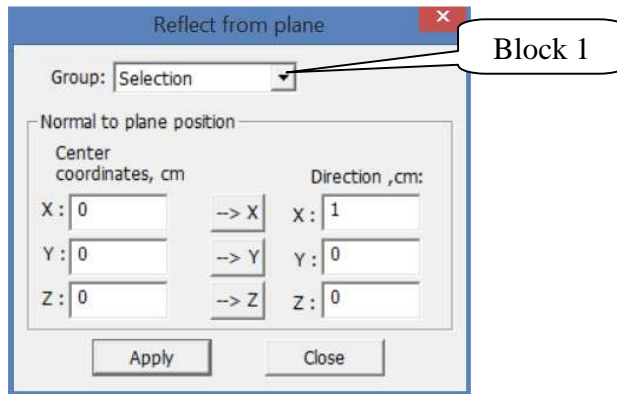



Figure 22.3. Window **Reflect from plane**

The most widely used tool for moving figures is the function of moving along the axis. To call it, press the button  in the toolbar, a window appears as shown on figure 22.4.

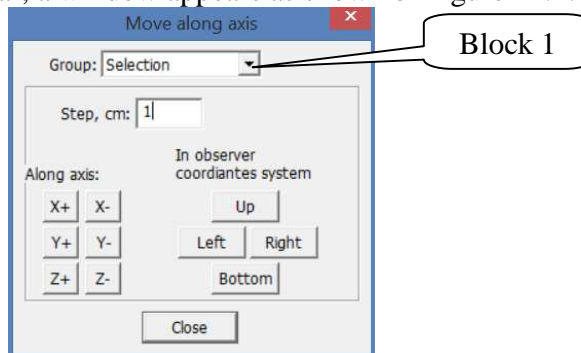

Figure 22.4. Window **Move along axis**

After selecting the step of moving the axis in the **Step** field and pressing the corresponding X +, X-, Y +, Y-, Z +, Z- buttons, the selected shape can be moved in the corresponding directions.

It should be noted that the operations of displacement, rotation and reflection can be performed not only over one figure, but also over several selected figures. To do this, select the items you want to move in the list of items before calling the appropriate tools.

Moreover, move operations are also available for groups. That is, if you select the group number in the **Group** drop-down list (see Fig.2.2.2, 22.3, 22.4, block 1) in the rotation or moving dialog box, the operation will be applied to the elements of the group number.

4 Calculation part

After constructing the geometric model of the experiment you should proceed to the calculation procedure. In this procedure the user also needs to create a physical model of the experiment, i.e. set the physical properties of objects, the characteristics of the sources, as well as the parameters of interaction of radiation with substance.

To go to the calculation part, the user calls the **Calculation** dialog box as shown in figure 23. To do this, press the button  in the toolbar of the main application window.

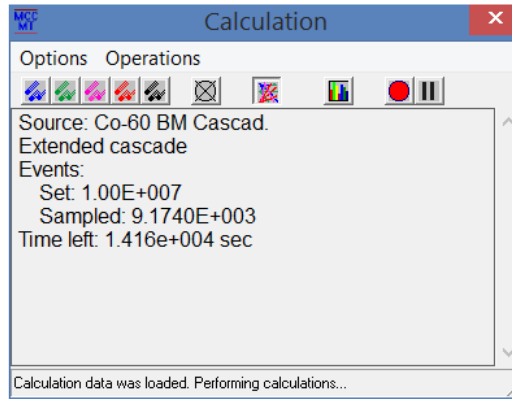
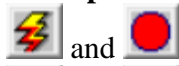

Figure 23. Window **Calculation**

In the **Calculation** window there is a menu, a toolbar and an information field in which the progress of the simulation procedure will be displayed.

The menu of the **Options** menu contains menu items that allow you to describe the physical model of a geometrically formed project. For example, the menu **Options** contains the following items: **Elements**, **Radiation Source geometry**, **Radiation type**, **Measuring mode**, **Calculation parameters**, **Materials**, **Radiation sources**.

The **Operations** menu section duplicates the toolbar buttons of the **Calculation** window:



and - **Start calculations** and **Finish calculations**.



and - **Suspend calculations** and **Resume calculations**.



- **Send histogram**. The action of this button causes the "MCC Viewer" module to be opened and the current calculated histogram is added to the spectra table. The button is available only during calculation.

4.1 Item Elements

Elements - this item opens a window where the list of user-created geometric elements of the project is displayed (see Fig. 24).

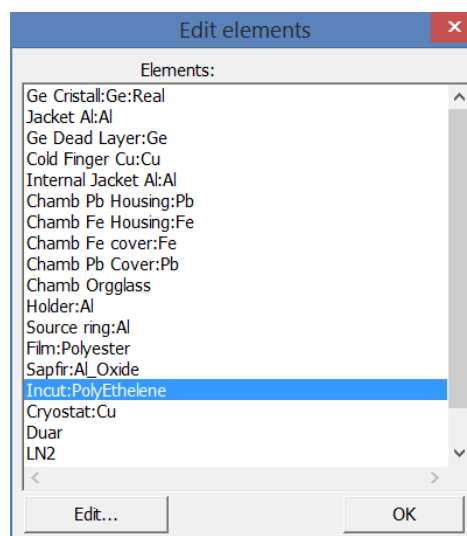

Figure 24. Window **Edit elements**

Using this window, the user must set the properties for each geometric element. To do this, select the element and click the **Edit** button. In the **Element properties** dialog box that appears, the **Element** field displays the name of the design element being edited (Figure 25).

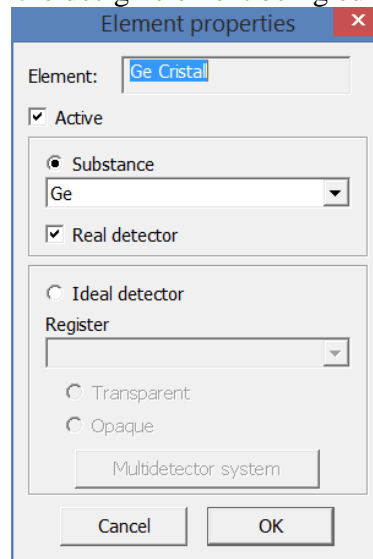

Figure 25. Window **Element properties**

The indicator **Active** shows whether or not this item will be active in the calculation. If the check box is not selected, then this element will be drawn, but will not be taken into account in the calculations. If the **Material** indicator is selected, you must select the material properties from the list that will be assigned to this element of design. In the materials list, only materials that are specified in the **Options-> Materials** section are available.

If a check mark is selected in the **Real detector** field, the element is assigned the properties of the detector in which energy losses are recorded.

If the **Ideal detector** switch is selected, this item will be considered as an ideal detector.

For the **Ideal detector** mode the following options are available:

- **Transparent** (detector) - the program captures the energy of particles trapped on the detector and passes them without changing the energy and angle.
- **Opaque** (detector) - the program captures the energy of particles trapped on the detector and does not pass the particles further (equal to an absolutely black body).

You can also choose which particles the program will capture in the **Ideal detector** mode: **gamma-quants, electrons, positrons, heavy particles, neutrons, or all**. If only one kind of particles is given, it means that only for these particles this element of the construction will have the properties of an '**ideal detector**'.

Button **Multidetector system** is only available for cylinder elements and rectangles designated by ideal detectors.

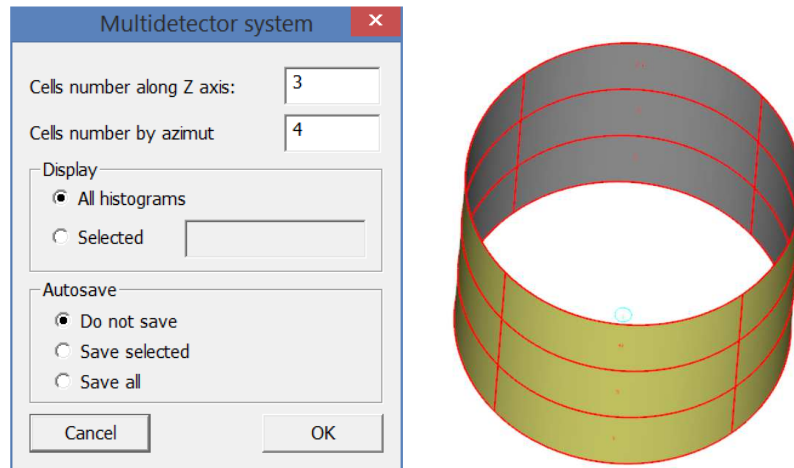

Figure 25.1. Window **Multidetector system**

4.2 Item Radiation source geometry

The menu item **Options->Radiation source geometry** opens the dialog box with the same name, in which you can set the position and geometric properties of the radiation source (see fig.26.1).

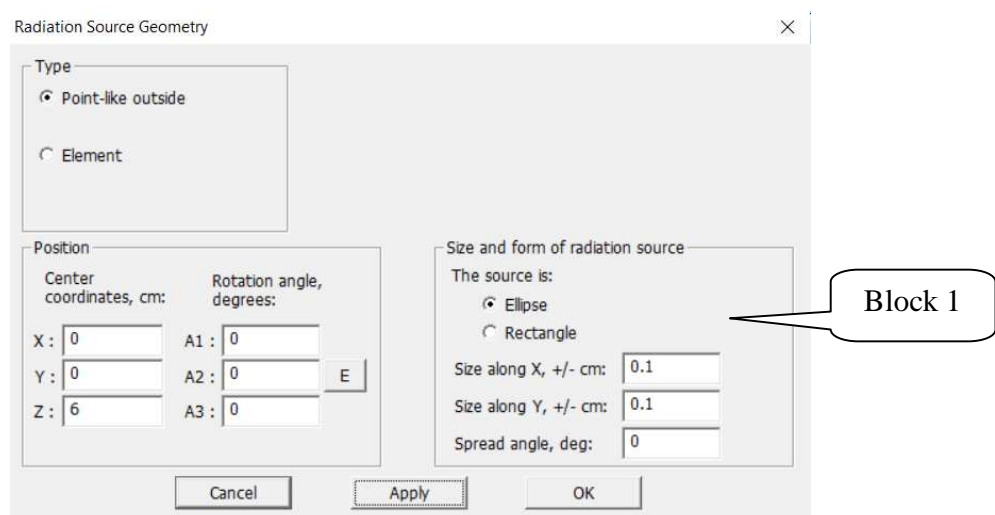

Figure 26.1. Window **Radiation source geometry** for **Point-like outside** type

The source geometry can be of two types:

- **Point-like outside** – The shape of the source is a plane whose geometric parameters are specified in the parameters group **Shape and size of the source** (Figure 26.1, block 1). The coordinates of the source must be outside of any element;

- **Element** – shape of the source of any geometric element of the design. In this case, the emitted particles will be isotropically generated in the volume of the selected elements and, consequently, this structural element will be a volumetric source. It should be noted that several elements can be set as a volumetric source, which will be considered by the program as a multi-element figure that constitutes the source (Figure 26.2, block 1).

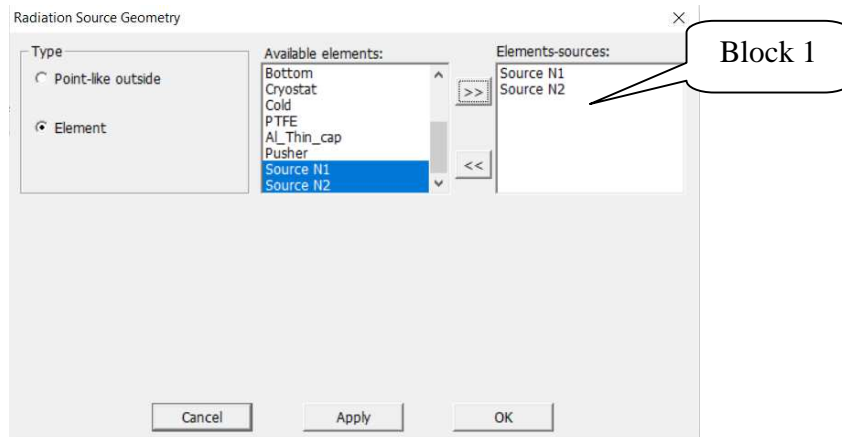

Figure 26.2. Window **Radiation Source Geometry** for type **Element**

The group of parameters the **Size and form of radiation source** are used for defining the geometrical parameters of the source:

- **Ellipse** - shape of the plane ellipse with the dimensions specified in the fields **Size X** and **Size Y**.

- **Rectangle** – the plane shape is a rectangle with the dimensions specified in fields **Size X** and **Size Y**.

- **Spread angle, degree** - the angle of separation of particles. If this value is 0, the particles will fly back to the normal direction of the source; if 90, the particles will fly only in the forward half-plane; if 180, the particles will fly isotropically in all directions.

The **Position** settings group is intended for setting the location and orientation in the source space:

- **Center coordinates, cm** - the position of the source center in the Cartesian coordinate system.

- **Rotation angles, degree**– fields in which the angles of rotation of the source relative to the corresponding axes are specified.

The **Apply** button allows you to apply the changes you made and preview. **Close** button - closes the dialog box.

4.3 Item Radiation type

The menu item **Options -> Radiation Type** opens the **Radiation Sources** dialog box, which requires you to set the source properties that will be used for the calculation. (see fig.27).

To set a monoenergetic radiation source, select the **Single line** item in the **Available radiation sources** list box and click the button ">>". In this case, the **Single line** item appears in the **Used radiation sources** field. After that, the group of parameters of the **Mono Lines** will become active, where you can select the source particle type (gamma quantum, electrons, positrons, neutron, heavy particle, elements of the Mendeleev periodic system) and set the monoliner energy in keV (see Fig.27.1). If you select elements of the periodic system, the program will treat heavy charged particles that are the nuclei of the given elements.

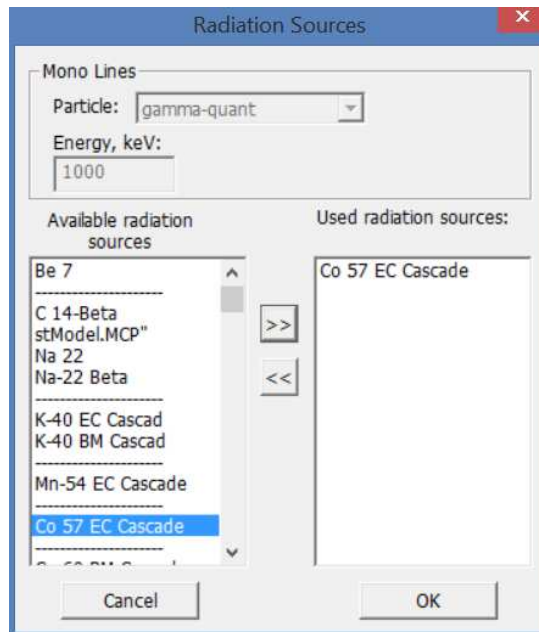

Figure 27. Window **Radiation Sources**

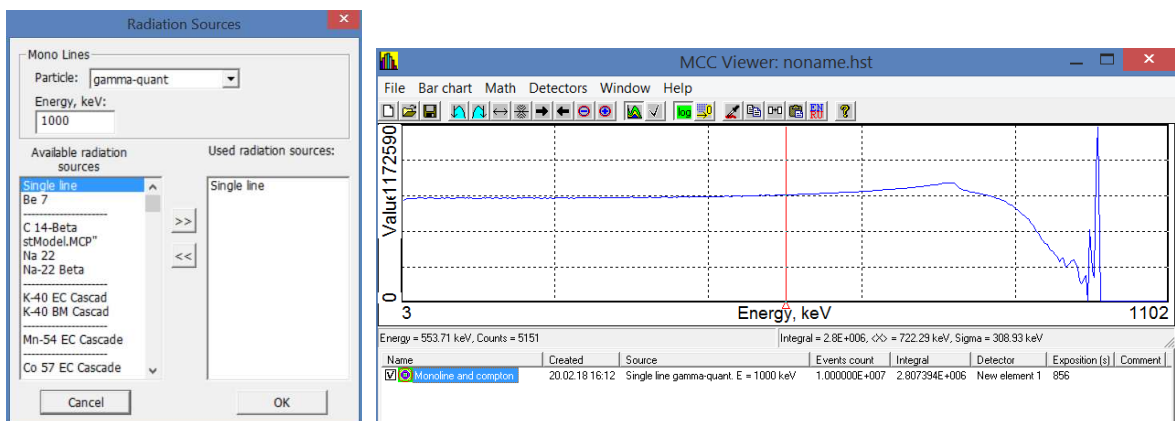

Figure 27.1. Setting the source as a Single line and the result in the form of a spectrum

To specify a more specific source (isotope, continuous spectrum, etc.), by pressing the ">>" and "<<" buttons, move from the left field the **Available radiation sources** in the right field **Used radiation sources** the required source. The list of **Available radiation sources** contains only predefined items that are available for editing in the **Options->Sources** section (see Section 4.6).

The user can specify several sources, in which case the calculation will be performed sequentially for each of them.

4.4 Item Measuring mode

The menu item **Options->Measuring mode** opens a dialog box of the same name in which the user can specify the parameters of the forthcoming calculation (see fig.28).

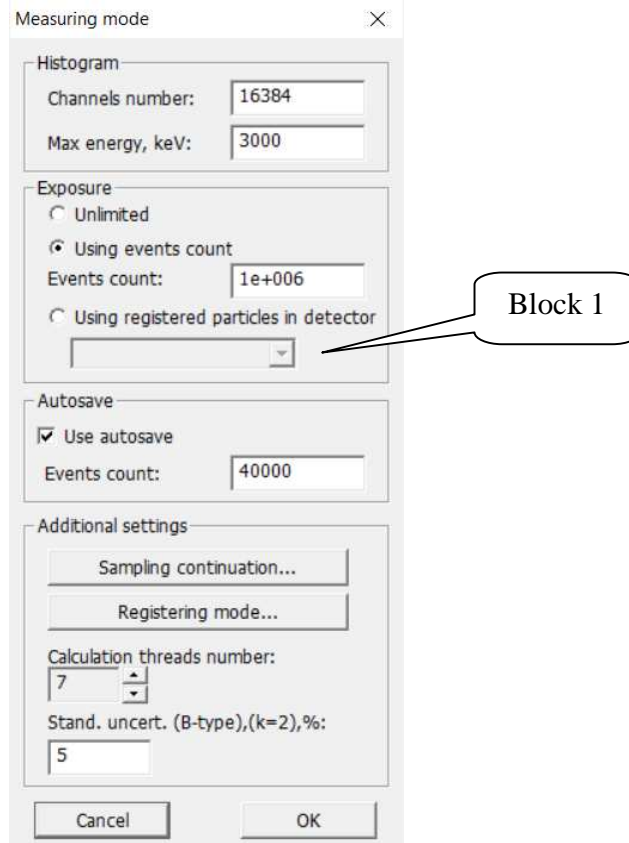

Figure 28. Window **Measuring mode**

In the **Histogram** group the parameters of the resulting spectrum are presented, namely

- **Channels number**– number of ADC channels (usually set in multiples of 512: 1024, 2048, 4096, 8192, 16384);
- **Max energy** – the maximum energy in keV that can be registered. Thus, the last channel of the spectrum will correspond to the maximum energy indicated in this field.

The **Exposure** group defines the number of events (decays) to be calculated by the program. So, when you select **Unlimited** type the program will generate events (decays) until the user stops the calculation. If you choose the option **Using events count** - you must specify the number of events (after the **Events count**, see Fig. 28), after calculating which, the program will stop the account. And the last option **Using registered particles in detector** - allows the user to choose after which number of registered events (indicated in the field **Events count**) and in which detector (indicated in the drop-down list see Fig. 28, block 1) the program will stop the calculation.

In the **Autosave** group the parameters that define the procedure for saving the spectrum in automatic mode. So, if the indicator **Use autosave** is signed the program will save spectrum to the module "**MCC Viewer**" after the calculation of the number of events specified in the **Events count**. If the **use Autosave** indicator is not set the program will record the results only after the calculation is complete.

There is **Sampling continuation** button in the **Additional settings** group. With this option, you can continue the calculation using the previously obtained results. By pressing this button in the window that appears, you need to specify the path to the files that store information about previously made calculations for this project. If you specify the number of events in the window **Measuring Mode** more than already calculated, the program will start executing taking into account this data and output the total result.

When you click the **Registering mode** button, the user calls the **Measuring scheme** dialog box, where you can configure an additional calculation order (see Figure 29).

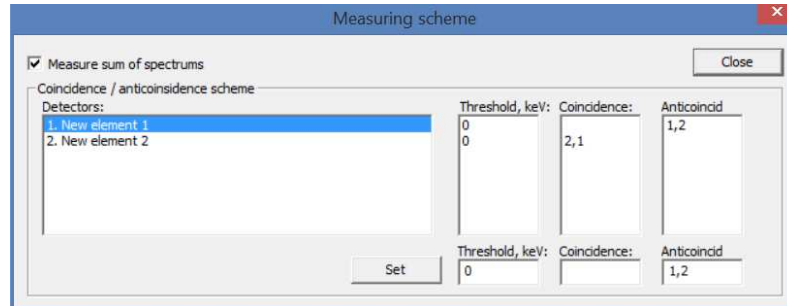

Figure 29. Window **Measuring scheme**

So, if you set the checkbox for the **Measure sum of spectra** indicator, the program will measure the so-called. Total spectrum, if several detectors are specified in the project. As a result, separate spectra from each detector and the total spectrum from all detectors will be calculated.

Group the **coincidence/anticoincidence scheme** is a set of parameters that allow the detectors to be included in the **coincidence / anticoincidence scheme** with each other. In the left field of **Detectors**, a list of preset detectors is displayed. The **Thresholds** field displays the specified threshold for registering in keV. In the field of **Coincidence and Anticoincidence**, displays specified registration scheme. The fixation of the particle in the detector can thus be determined not only by the physical absorption in the detector, but also by the presence / absence of absorption in the coincidence / anticoincidence detector.

In Figure 29, is given a registration scheme that allows to obtain the spectrum of the anticoincidence of the signals of the first detector ('Detector 1') with the second detector ('Detector 1'), i.e. the particle will be detected in the spectrum only if it is detected in the first detector, but no particle has occurred in the second particle detector. Also, the described scheme (Fig. 29) allows to obtain another spectrum of coincidences for 'Detector 2', i.e. the particle will be registered in the spectrum in the event that a particle is also registered in the 'Detector 1' at the same time.

The result of calculation according to this scheme is shown in Figure 29.1.

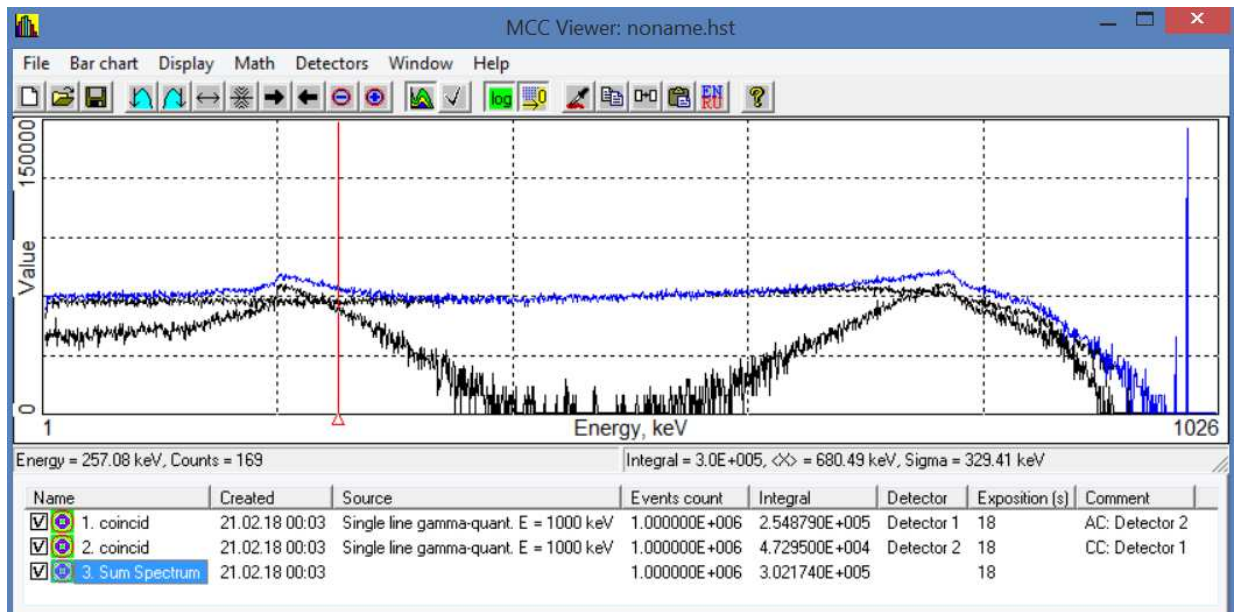

Figure 29.1. The window with the results of calculating the spectra by the coincidence scheme

The field of discrete values **Calculation thread number** is intended for specifying the number of processors cores of computer used in computing. It should be noted that when specifying the number of cores more than there is in the computer, the calculation will be performed using the actual number of cores.

The value specified in the field **Stand.uncert.(B-type),%** allows you to specify the uncertainty that will be used in the calculation of the efficiency curve.

4.5 Item Calculation parameters

The menu item **Options -> Calculation parameters** opens the **Processes of interaction** dialog window, where user can define the parameters of the forthcoming calculation, directly related to the physics of the processes, i.e. peculiarities of interaction of radiation with substance (see Fig.30.1).

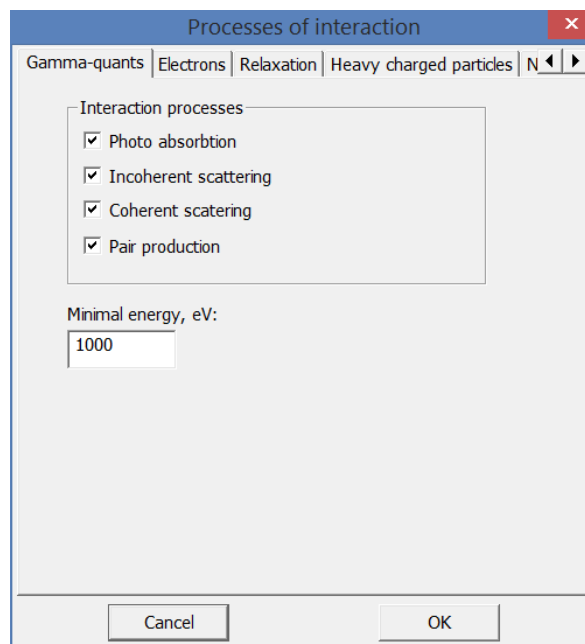

Figure 30.1. Window **Processes of interaction**, **Gamma-quants** tab

On the **Gamma-quants** tab in the **Interaction processes** group, you can specify what types of interaction the program should take into account when calculating: 'Photo absorption', 'Incoherent scattering' (Compton scattering), 'Coherent scattering', 'Pair production'.

In the **Minimal energy** field, you can set the minimum energy value. Gamma quanta with energies below this value will not be taken into account in calculating.

The **Electrons** tab contains parameters that determine the interaction of electrons with matter (Fig. 30.2).

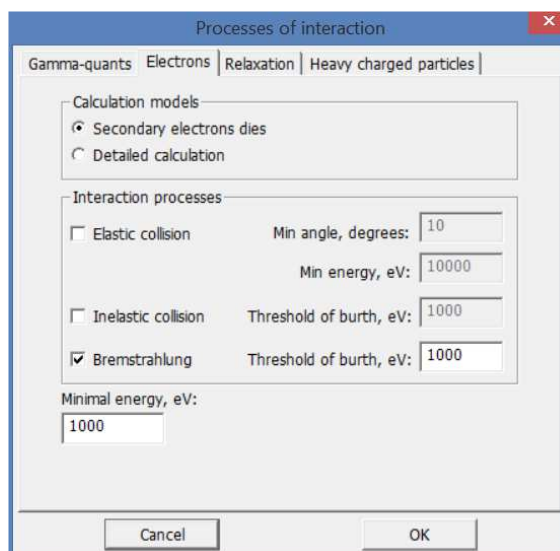

Figure 30.2. Window **Processes**, **Electrons** tab

In the **Calculation models** group, the user can select the mode **Secondary electron dies**. This means that when you set this mode of calculation, the electron will be absorbed at the point of birth. This mode reduces calculation time and is suitable for test calculations.

In the **Interaction processes** group on the **Electrons** tab, the user can specify which types of interaction the program should take into account in the calculation ('Elastic collision', 'Inelastic collision', 'Bremstrahlung'), and parameters of these types:

Min. angle, degree - angle in degrees, from which the process of elastic scattering is calculated in detail. The smaller angle the longer calculation.

Min. energy - this is the minimum electron energy for which elastic scattering is generally played out. It is recommended to set this parameter higher than the parameter Minimum energy, keV (see Fig. 30.2). The fact is that the electron has a small run. The lower the energy, the less important it is. In this case, the electron should not be prematurely excluded from the calculation, since it can give birth to a brake quantum

Birth threshold - this is the minimum value of the energy of the produced secondary "inelastic" electrons or bremsstrahlung quanta. It makes sense to put this energy just above the basic **Min. energy** in order to accelerate calculations.

The **Relaxation** tab shows the parameters that determine the need to take into account the relaxation process (see Figure 30.3). If there are no ticks for the indicator **Sample relaxation** the relaxation process is excluded from consideration. This means, for example, that if an electron was knocked out from the K shell, then nothing will be generated from the excited atom, neither the characteristic quantum nor the secondary electron. The energy released to such particles will be absorbed at the point where the photoelectric effect occurs. It is not recommended to remove this sign because it does not greatly accelerate the calculation, but it reduces the accuracy.

The indicator "Take into account the Auger electron" allows you to turn on / off the process of relaxation processing through the outer shell electron. Removing the tick of this indicator allow to absorb Auger electrons in the calculation at the point of birth.

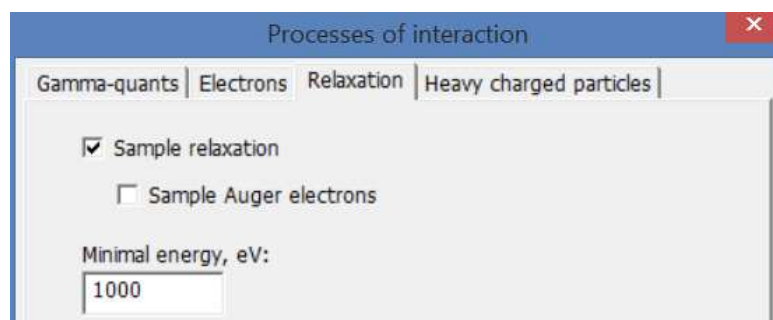

Figure 30.3. Window **Processes of interaction**, the **Relaxation** tab

On the tab **Heavy charged particles**, the parameters defining the interaction of heavy charged particles with matter are given (Fig. 30.4).

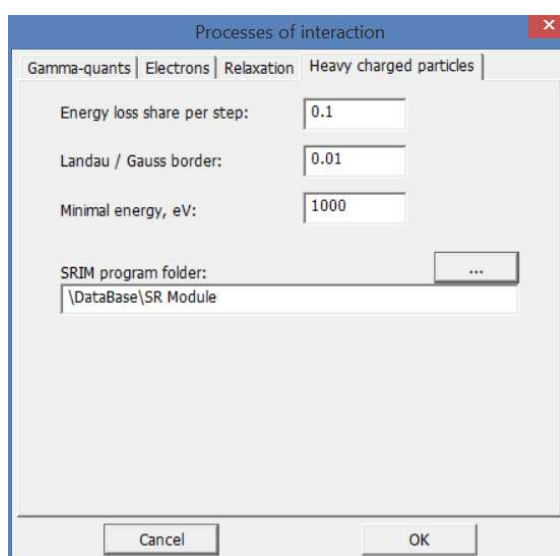

Figure 30.4. Window **Processes**, **Heavy charged particles** tab

To calculate the transit of heavy charged particles, the energy dissipation model is used, the data from the SRIM program are taken for its implementation. In the frame of the modeling and based on the known parts of the energy loss in the step (parameter **Energy loss share per step**), a step is calculated in which a certain energy is lost according to the Landau or Gauss distribution. Further, the angle of underlie is calculated from the lost energy. Such way the calculation is conducted, until the threshold energy is reached (specified in the parameter **Minimal energy, eV**). Then the particle is absorbed. For more detailed description of the calculation HCP see the document "HeavyIons Report.doc".

On each tab of the window **Processes of interaction** the **Minimum Energy** field is shown. This field shows that if a quant, electron, positron or alpha particle reaches an energy below this value, then they are absorbed.

4.6 Item Materials

The menu **Options** -> **Materials** opens the dialog box **Substances**, where lists of the available materials are indicated. These materials can be binding to the geometric figures of the project (see Fig. 31). User can add new or edit properties of already created materials.

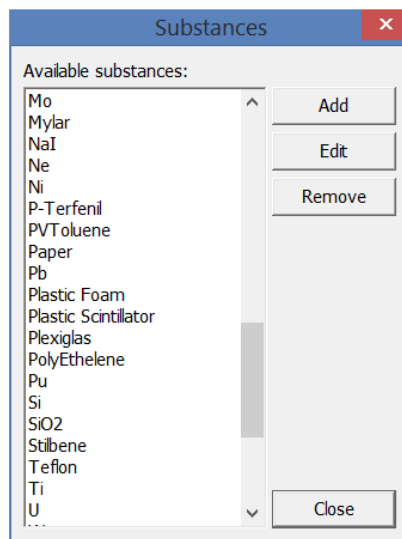

Figure 31. Window **Materials**

The **Add** button opens a dialog window for adding and setting properties for the new material (see Fig.32).

The **Edit** button calls up a similar window as shown in Figure 32, but only to change the properties of the selected material from the list.

The **Delete** button is intended to delete the selected material from the list.

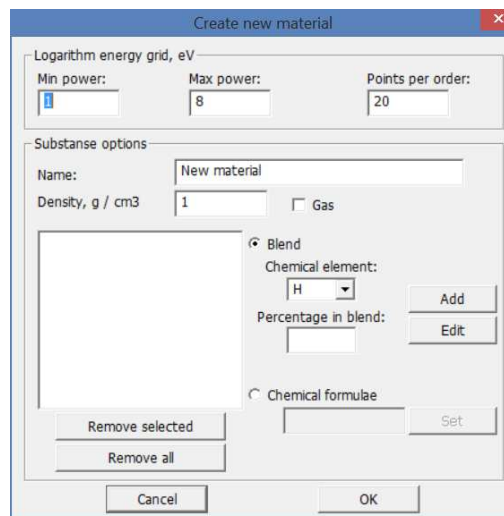

Figure 32. Window **Create new material**

To add new material to the database you need to perform the following set of actions (see Fig.32):

- in the **Name** field enter the name of the created material;
- in the **Density** field, enter the density of the created material;
- it takes choose the way to specify the material - **Blend** or **Chemical Formula**;
- for the case of the **Blend**, select the chemical elements in the **Chemical element** drop-down list and their parts in the composition of the material and click button **Add**.
- for the **Chemical formula**, enter the chemical formula in the appropriate field and click **Set**.

- the parameters of the formed material will appear in the middle field, namely the atomic number of the constituent elements and their share (see Fig.33).

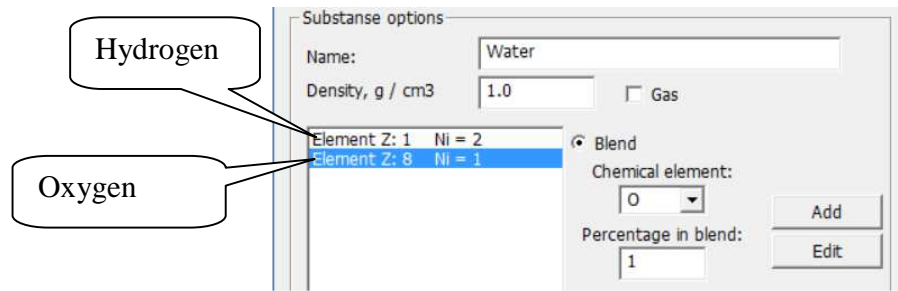

Figure 33. Example of material *Water*

To change an element or its share select it in the list, make corrections and click button **Edit**. The **Delete** button deletes the selected material elements. The **Delete All** button deletes all material elements.

In the field **Logarithmic energy grid** the initial and final degrees in the logarithmic energy scale are shown for which the cross sections will be calculated and how many calculated points distributed linearly along the logarithmic scale fall on one order.

After you enter all the required values in the window **Create New Material**, click **OK**. The new material will be added to the database. The name of the newly created material will appear in the materials list.

4.7 Item Radiation Sources

The menu **Options** -> **Radiation Sources** opens the dialog window **Radiation source database**, which contains lists of the sources of radiation available to user for modeling (see Fig. 34). User can add new, delete or edit properties of already created sources.

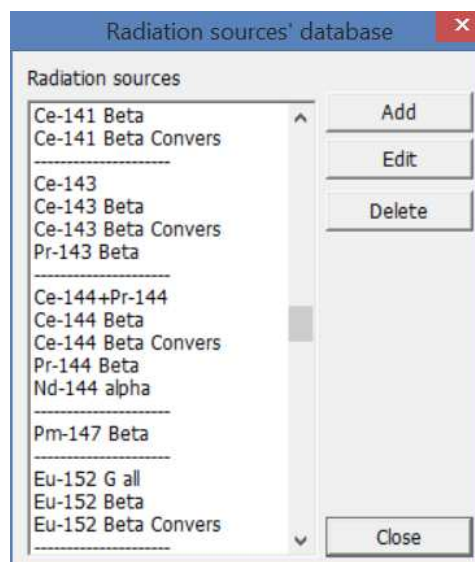

Figure 34. Window **Radiation source database**

The **Add** button opens a dialog for adding and setting properties of a new source (see Fig.35).

The **Edit** button calls up a similar window as shown in Figure 35, but to change the properties of the selected source from the list.

The **Delete** button is used to delete the selected source from the list.

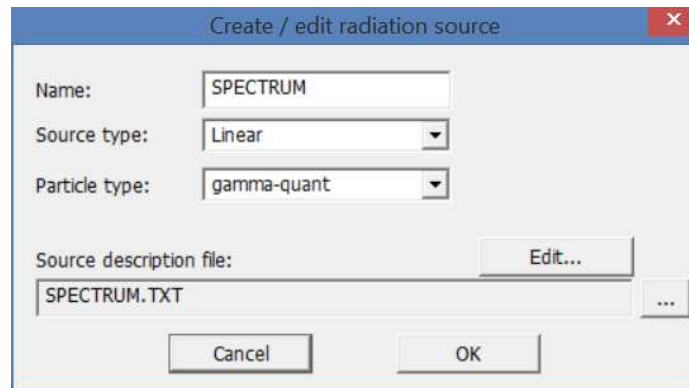



Figure 35. Window **Create / edit radiation source**

To add a new source to the database, you must implement the following set of actions (see Fig.35):

- in the field **Name** enter the name of created source;
- in the field **Source type** select the source type from the drop-down list:
 - 'Linear' - the usual linear source type, where only particles of a strictly defined energy are emitted with a given probability. A characteristic type for most isotopes.
 - 'Continuous' - spectrum of the emitted particles of this source will be continuous. On the entered values of energy and the probability of emission, a continuous spectrum will be generated (for example, X-ray bremsstrahlung).
 - 'Full cascade' - in a real experiment there is a probability of detecting simultaneous hits of two or more quanta (particles) in the detector, since their emission occurred simultaneously, such events lead to the appearance in the spectrum of lines with an energy equal to the sum of the quanta (particles). The choice of the 'Full cascade' type allows to take into account this factor and the lines corresponding to such cascade quanta (particles) can be observed in the spectrum. For this type a specially formed file is needed where the probabilities of the transition from one level of excitation to the other and the probability of emission of quanta of the corresponding energies are indicated.
 - 'Continuous beta' - a source with a beta spectrum is a particular case of a source with a continuous spectrum. This source emits either electrons, or positrons, or both.
- in the **Particle type** field select from the drop-down list which particle types will be emitted by the source ('gamma quant', 'electron', 'positron', 'neutron', or element of the periodic system of Mendeleev).
- the **source description file** field is intended to indicate in it the generated source file by means of a button . You can open this file (text file) in **Notepad** by clicking the **Edit** button. If the file does not exist, then by clicking the **Edit** button a new file will be created with the name specified in the field.

4.8 Formats of source files

According to the type of the source, the file format can be different.

For the type 'Linear' and 'Continuous' in this file it is necessary to introduce the particle energies into keV and the probability of particle emission per decay (in percents) in the following format (see Fig.36):

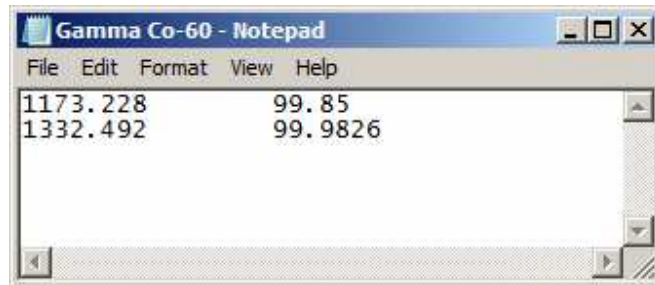

Figure 36. The view of the source file editor window (for 'Linear')

For the "continuous beta" source type, the file format is as follows (see the example in Figure 36.1).

In the first line there is letter "Z", then through the blank the charge of the decaying core. Then the set of lines that determine the type of particles, energy and probability goes. Each line specifies the type of particle, the maximum energy of the β -spectrum, the probability of emission of a particle of the given β -spectrum by 1 decay in percent. The particle type is specified using the symbols "B-", "b-", "B +", "b +". The first two characters specify the β -spectrum, the second β + spectrum.

Thus, the source consists of several sources with a continuous spectrum. The continuous β -spectrum is calculated using an analytic formula that depends on the nuclear charge, the maximum energy of the β particle and the type of the emitted particle.

The use of the analytical approximation is justified, since the analytical formula describes the β spectrum with high accuracy. There is no need to specify the spectrum in the form of a set of continuous spectrum lines.

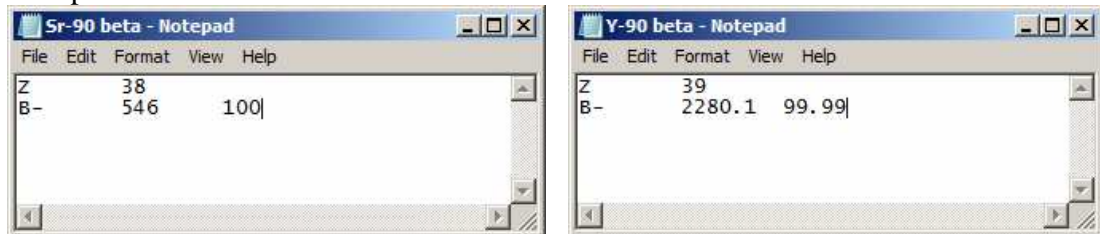

Figure 36.1. The view of the source file editor windows (for the 'Continuous beta' type), radionuclide Sr-90 - left, radionuclide Y-90 - right.

For the 'Full cascade' source type the file format is as follows (see the example in Figure 36.2). There is a whole layer of simulation problems when it is necessary that the radiation source fully describe the process of radioactive decay and all its products. The source type 'Full cascade' allows to describe fully radioactive decay and all its products. In one act of decay in the general case several particles of different types are emitted. This is actually a decay product, gamma quanta and conversion electrons emitted during the removal of excitation by the nucleus. The emission of conversion electrons leads to the formation of vacancies on atomic shells. These vacancies are filled in the process of atomic relaxation. This, in its turn, leads to the emission of X-ray quanta and Auger electrons. Thus, in the process of modeling a source, it is necessary not only to quantitatively accurately generate events, but also to take into account which particles are emitted simultaneously and which ones are not.

To specify the source 'Full cascade', a special file format was proposed that takes into account all the physical processes mentioned above and sequences of nuclear and atomic transitions.

Below is the description of the source file as the example of the alpha decay of the isotope Am-241 (see Fig.36.2).

The first line in the combined source file contains explanatory information about the columns.

The second line records the atomic number of the decaying nucleus (95 for americium).

The third line contains the chemical symbol of the element, written in capital letters. This is necessary in order for the program to load information about the source material, which is necessary when generating events inside volumetric sources.

Then follows a set of lines describing the type, energy, decay probability and core levels.

The first column, labeled "Type", contains the type of particle emitted. The following types of particles are supported:

- 1) «A» – alpha particle.
- 2) «BM» – electron emitted during β -decay.
- 3) «BP» – electron emitted during $\beta +$ decay.
- 4) «EC» – electron captured by the nucleus due to electronic capture.
- 5) «CK», «CL», «CM», «CN» – conversion electrons emitted from K, L, M, N shells, respectively.
- 6) «G» – gamma rays.
- 7) «Auger K», «Auger L», «Auger M», «Auger N» – electrons of Auger.
- 8) «XR N» - characteristic gamma quanta

Type	I	E, keV	InitLev	FinLev
95				
AM				
A	0.0007	5155	-	20
A	0.0009	5182	-	18
A	1e-005	5217	-	15
A	0.0024	5244	-	12
A	0.0005	5279	-	10
A	0.015	5322	-	8
A	1.66	5388	-	6
A	0.01	5416.5	-	5
A	13.1	5442.8	-	4
A	0.02	5469	-	3
A	84.8	5485.56	-	2
A	0.225	5511.5	-	1
A	0.37	5544.5	-	0
CL	14	3.9178	2	1
CK	0.000188	4.37	8	4
CK	0.000951	6.62	6	1
CL	17.4	10.7692	1	0
CL	0.32	20.277	3	1
CM	3.6	20.621	2	1
CL	9.1	20.993	4	2
CM	4.4	27.473	1	0
CK	9.9e-005	27.87	12	6
CL	1.5e-005	28.58	15	11
CK	1.14e-005	31.36	8	3
CL	0.89	33.133	6	4
CM	0.083	36.981	3	1
CL	30.2	37.1141	2	0
CM	2.4	37.697	4	2
CL	4.4e-005	42.403	15	9
CL	0.01	45.02	8	6
CM	3.7e-006	45.29	15	11
CK	1.33e-005	46.01	14	6
CK	6e-005	47.13	14	6
CL	0.00073	47.33	4	1

Figure 36.2. The window of the source file editor (for the 'Full cascade')

In the second column, labeled "I", the probability of radiation of a given particle in percent for one act of radioactive decay – P_i^{100} .

The third column contains the energy of the emitted particles in keV. In the case of electron capture, this is the energy acquired by the nucleus in the process of this reaction.

The fourth column records the initial level of the nucleus from which the particle is emitted. This level is relevant only for secondary decay particles. For primary particles, the initial level is absent, so the column indicates a dash.

The last column contains the nuclear level number to which the particle passed in the process of removal by the excitation nucleus.

To optimize the process of generating a source file for the 'Full cascade' type, an additional program "**SpectrumProd**" is used (see the document Description of the program "**SpectrumProd** ").

5 Draw settings

The **Draw settings** window is called up by pressing the button  in the main toolbar of the program "**MCC-MT**" (see Fig.37).

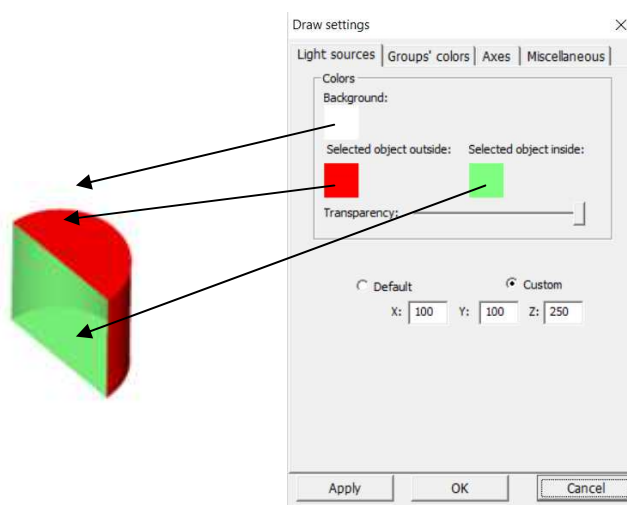

Figure 37. The **Draw settings** window, the **Light sources** tab

This window allows you to customize the appearance of the scene. So, the **Light sources** tab allows you to customize the color surfaces of shapes.

The **Groups colors** tab allows you to customize the colors of the elements according to their group number.



Figure 38. The **Draw settings** window, the **Groups colors** tab

The colors set on this tab are used by default only when adding a new element. Further, the user can set the color of each element individually (including the degree of transparency) in the parameters window for each element.

The **Axes** tab is used to adjust the display of the coordinate axes. You can change the color of the axes, the color of the letters (X, Y, Z), the font, the location of the axes, and their length.

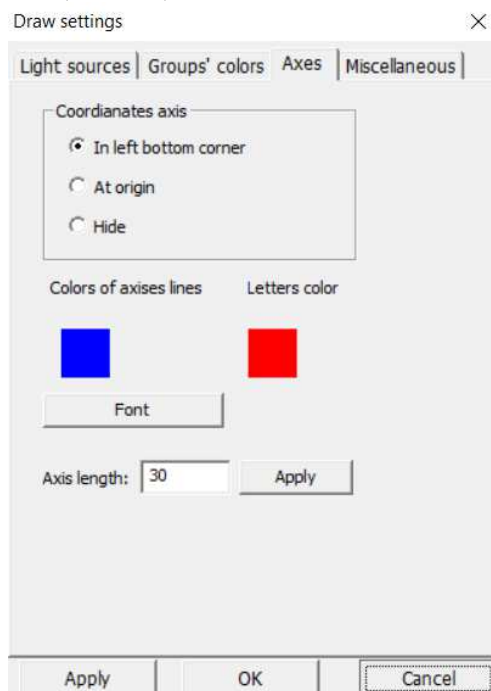

Figure 39. The **Draw settings** window, the **Axes** tab

On the **Miscellaneous** tab, you can see additional and advanced display options.

6 Spectrum mapping module

In order to provide a tool for working with spectra a software module "MCC Viewer" was created. It makes it possible to obtain the calculated spectra from the main part of the "MCC-MT" program, display them, and perform various manipulations including the so-called blurring.

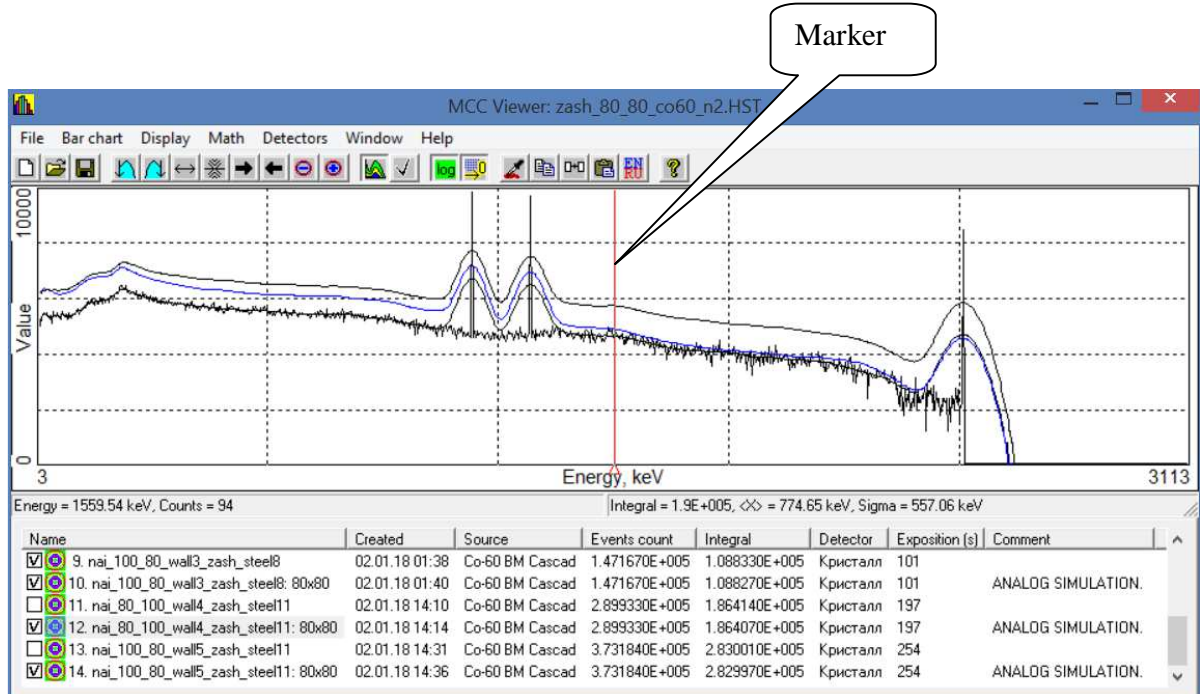



Figure 40. Appearance of the module "MCC Viewer"

The appearance of the module "MCC Viewer" consists of a main menu, a toolbar, a panel with histograms of spectra and a table with the names of the spectra and some of their data (see Fig.40).

The data of the module "MCC Viewer" is stored in a file with the extension *.hst. It can contain any number of spectra in one file.

6.1 Items of the main menu File

New – allows you to clear the current contents of the module. Item duplicated as a button  in the toolbar.

Open – allows you to open a previously saved file *.hst using the standard file open dialog. Item duplicated as a button  in the toolbar.

Append – allows you to add spectrum histograms to the current list via the standard file open dialog.

Save, Save as – allows you to save the current list of spectra in the file *.hst. Item **Save** duplicated by button  in the toolbar.

Export / import file – allows you to save or load a spectrum from the list in several formats (*.txt, *.asw).

Save configuration file, Open configuration file – allows you to save and restore (i.e. load) the configuration of the spectra display and other settings of the module "MCC Viewer".

6.2 Items of the main menu Bar chart

Set name and comment – calls the **Histogram properties** window with the parameters of the currently selected spectrum and allows you to change them (see Fig.41). The **Histogram properties** window can also be invoked by double-clicking the left mouse button on the desired spectrum in the table of spectra.

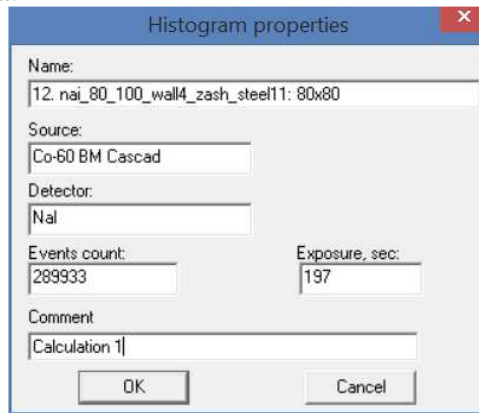



Figure 41. **Histogram properties** window

In this window the name of the spectrum is specified in the **Name** field. The **Source** field shows the type of the calculated source. The **Detector** field indicates the name of the element in the role of the detector, in which the particles are registered. In the **Comment** field, the user can enter a comment for this spectrum.

The **Events count** field indicates the number of events calculated and the **Exposure** field indicates the time of the calculation of this spectrum was performed. It should pay attention that the value of **Exposure** in this case has different meaning than in the ordinary sense, it's just an astronomical time that was spent for calculation events, and it cannot be used to determine the intensity of registration in the channels. The resulting spectra are referenced to 1Bq. Therefore the **Events count** is identical to the live time of measurement in the ordinary spectrometric sense. Precisely the value the **Events count** should be used in order to obtain the spectrum in units of intensity cps (count per second).

Add copy - for current selected spectrum in the table creates a copy of it and adds it to the end of the table. This item is duplicated in the by button  in the toolbar.

Delete – delete the current selected spectrum in the table. This item is duplicated in by button  in the toolbar.

Delete all checked – procedure for deleting all the spectra of the selected by tick in the table.

Set channel value– calls a dialog box where user is able to specify a value for a certain channel in the spectrum (see Fig.42).

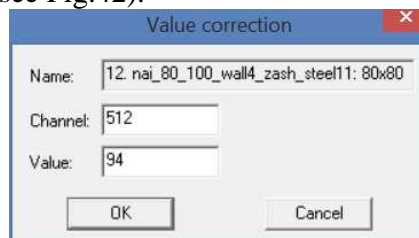

Figure 42. Window **Value correction**

6.3 Items of the main menu **Display**

Display configuration – calls up the **Chart settings** dialog box (see Figure 43) where user can change the appearance of the spectrum display on the graph.

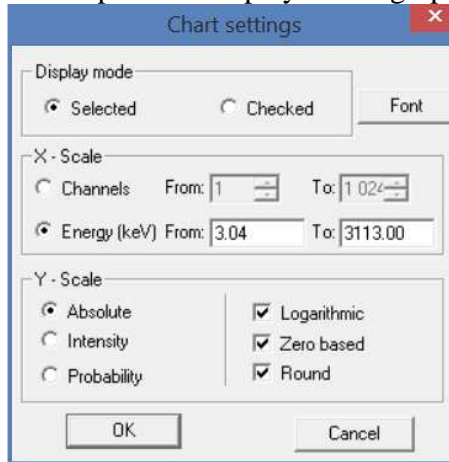







Figure 43. **Chart settings**

Group **Display mode (Selected / Checked)** - duplicates the button  in the toolbar of the module.

The parameter group **X-Scale** essentially defines the scale boundaries for scaling purposes.

The **Logarithmic** indicator change the scale along the Y axis to the logarithmic mode. This indicator is duplicated by the button  in the toolbar.

The **Zero-based** indicator links the scale of the spectrum to the zero value. This indicator is duplicated in the form of the button  in the toolbar.

Set left border / Set right border – menu items designed to scale graphics. Before clicking on this item, you need to move the marker (see Fig. 40) to the channel that should become the left border of the graph, and then click **Set left border**. To change position of the marker move the mouse cursor over the marker area and click left mouse button and by pressing it move it to the desired position. To set the right border repeat the procedure and click **Set right border**. These items are duplicated as the buttons  and  in the toolbar.

Defaults borders – Performs the cancellation of scaling to the original view. Duplicated as a button  in the toolbar.

Check all charts– sets the checkboxes for each spectrum in the table.

Uncheck all charts – removes tick marks for all spectra in the table.

Invert checks – changes the status of the checkmark to the opposite for all spectra in the table. Duplicated as a button  in the toolbar.

6.4 Main menu items **Math**

Energy calibration - calls up the **Energy Calibration** dialog box (see Figure 44), which allows you to change the energy calibration if necessary by setting new points or adjusting existing ones. You can also change the degree of the polynomial describing the channel's energy dependence on energy.

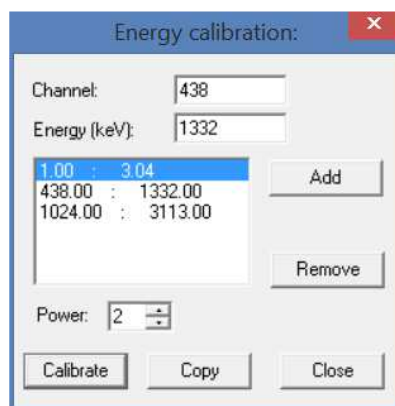

Figure 44. Window **Energy calibration**

After making corrections click the **Calibrate** button. The table defining the point for energy calibration can be copied to the clipboard by clicking the **Copy** button.

Composition - calls the dialog box of the same name (see Fig.45), which allows to combine two spectra with each other in order to obtain a common spectrum.

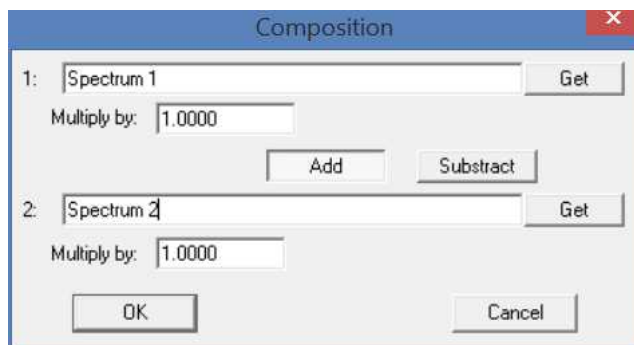

Figure 45. Window **Composition**

To perform the operation after calling this window, select the first spectrum in the table and click the **Get** button to the right of the **1-st** field. This field displays the names of the first spectrum for the operation. Next, you need to repeat the operation with the second spectrum using the **Get** button to the right of the **2nd** field. To select the type of operation (addition or subtraction), click the corresponding **Add** or **Subtract** button. If necessary the spectrum can be multiplied by constant, for that it is necessary to specify this value in the corresponding fields **Multiply by**. After clicking on the **OK** button, the composition spectrum appears at the end of the table (see Fig.46).

Sum all checked – performs a similar task, like **Composition**, but only for all spectra marked with a tick in the table (see Fig.46).

Energy Scale – allows you to set the maximum energy value for all spectra of the table.

Set channels count – allows you to set for all spectra of the table the number of channels in the spectrum.

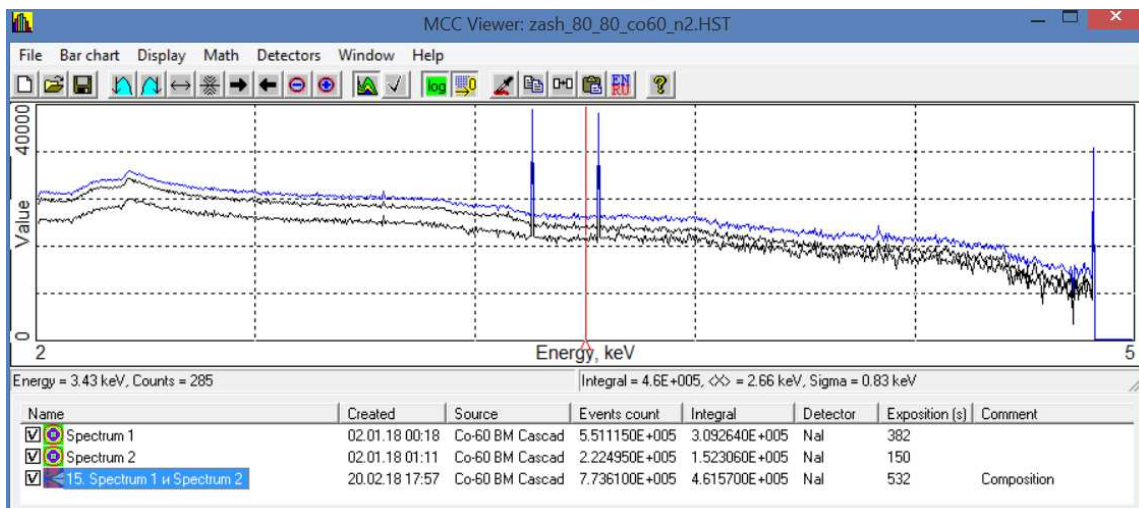

Figure 46. The result of summation of two spectra

6.5 Items of the main menu **Detectors** (see fig. 46.1)

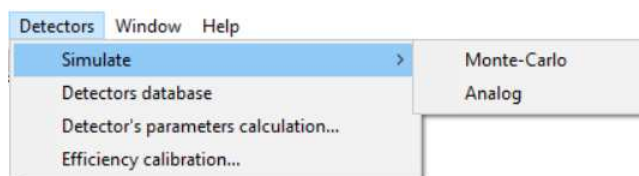

Figure 46.1 Menu item **Detectors**

Item **Simulate** contains two sub-items – **Monte-Carlo** and **Analog**. These menu items are designed to perform the so-called blurring of the ideal spectrum, which is a function of the detector response, to the real spectrum emulating the spectrum obtained on the real spectrometer.

Item **Simulate->Analog** - in this case the program uses the analytical formula. In the argument of the function are the detection parameters of the detector and the energy of the particle. As result the function outputs a set of pairs of numbers (energy-coefficient). This is a certain distribution with a center equal to the given energy.

Simulate->Monte-Carlo - in this case the program for each event in each channel starts the random number generator and calculates the registration energy in this detector for this event. Also in this case, the detector parameters and energy are used. This is a more accurate option, but a slower one.

The **Detectors database** item opens the **Detectors Database** dialog box, which displays an existing list of types of real detectors (see Figure 47).

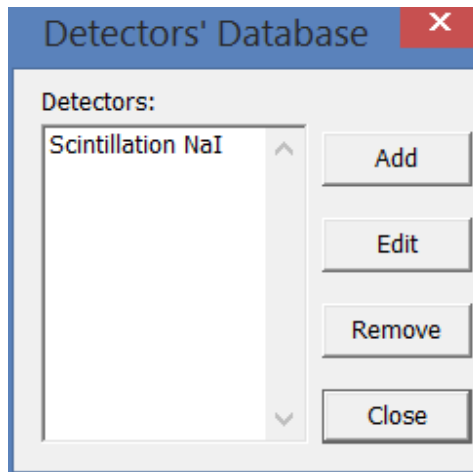

Figure 47. Window **Detectors Database**

To add a new type of detector click the **Add** button to the right of the list, after that another window will appear on the screen where the user needs to enter the parameters of this detector and click **OK** (see Fig.48). To edit the parameters of the type of detector selected in the list, click the **Edit** button. As a result the window will reappear as shown in Figure 48.

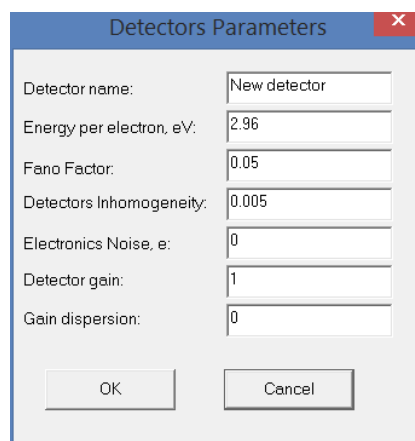

Figure 48. Window **Detectors Parameters**

Within the parameters of the detector are the following values.

Detector name - the name of a particular detector. It should be noted that the detector parameters can be changed even for the same type.

Energy per electron, eV – the average energy ε , spent on the formation of a single charge in eV. For gas detectors, $\varepsilon = 25$ to 30 eV, for germanium semiconductor detectors $\varepsilon = 2.96$ eV, for scintillation detectors this value of ε is determined by the light output of C1, the light-gathering coefficient for the photocathode of photomultiplier C2 and the photocathode conversion coefficient C3. For example, for NaI (Tl) $C1 = 38$ F / keV, $C2 = 0.5 - 0.9$, $C3 = 0.15 - 0.25$. Therefore, ε can be:

for NaI(Tl) : $350 - 117$ eV

for CsI(Tl) : $370 - 137$ eV

Fano Factor – a parameter that determines deviations from the average ionization efficiency, which is caused in the medium by radiation. For scintillation detectors, its value is 1, for gas detectors from 0.2 to 0.5, for germanium semiconductor detectors from 0.05 to 0.1.

Detectors inhomogeneity– parameter that determines the nonuniform distribution of the impurity of the activator in the scintillation detector, the incompleteness of charge collection in the semiconductor detector and the imperfection of the filament in the gas proportional counter. For scintillation detectors its value is from $1 \cdot 10^{-3}$ to $1 \cdot 10^{-5}$, for gas detectors its value is from $1 \cdot 10^{-4}$ to $1 \cdot 10^{-5}$, for germanium semiconductor detectors its value is from $1 \cdot 10^{-5}$ to $1 \cdot 10^{-7}$.

Electronics Noise, e - the number of noise charges fluctuating at the input of the preamplifier. This value depends on the time of formation in the main amplifier and the noise characteristics of the preamplifier, and can vary from 2000 for poor amplifiers to 30 for high-qualitative.

Detector gain – factor of gain in the detector. For scintillation detectors its value is from $1 \cdot 10^4$ to $1 \cdot 10^6$, for gas detectors from $1 \cdot 10^3$ to $1 \cdot 10^5$, for germanium semiconductor detectors - 1.

Gain dispersion – parameter that determines the root-mean-square relative scatter of the gain of the detector. For scintillation detectors its value is equal to $\delta(G)^2 = 1/(\sigma-1)$, where σ is the secondary emission coefficient of dynodes. For example, for a 10-diode PMT:

with $G = 10000$, $\sigma = 2.5$, $\delta(G)^2 = 0.67$

with $G = 100000$, $\sigma = 3.2$, $\delta(G)^2 = 0.45$

with $G = 1000000$, $\sigma = 4.0$, $\delta(G)^2 = 0.33$

For gas detectors (proportional counters) $G = 1000$ до 10000 , a $\delta(G)^2 = 0.67$. For germanium semiconductor $G = 1$, a $\delta(G)^2 = 0$.

When calculating the energy resolution of the detector the following formula is used:

$$R = 236 \cdot \sqrt{(F + \delta(G)^2) \cdot \varepsilon / E + B + \left(\frac{N \cdot \varepsilon}{G \cdot E}\right)^2} \quad (6.1)$$

where R – full width of peak at half maximum (FWHM), %;

F- Fano factor;

E- absorbed energy, eV;

B- coefficient determining the imperfection of the detector;

ε – average energy spent on formation of a single charge, eV;

N – number of noise charges.

Starting from formula 6.1 it follows that the contribution of the various terms of the radicand to the energy resolution of the detector depends on the energy E absorbed in the detector. At very low energies the contribution of the last term in the subcortical expression is great, at medium energies the first term is decisive, at high energies the energy resolution of the detector is determined mainly by its imperfection - the coefficient B.

Obviously, the selection of correct values for each detector is a very laborious task. To simplify and automate this process the tool is provided that automatically creates the entire block of required parameters. This tool is called by selecting the menu item **Detectors-> Detectors parameters calculation**.

In the dialog box **Blur parameters calculation** (see Fig. 49) it should enter the aprior data in block 1 (Fig.49).

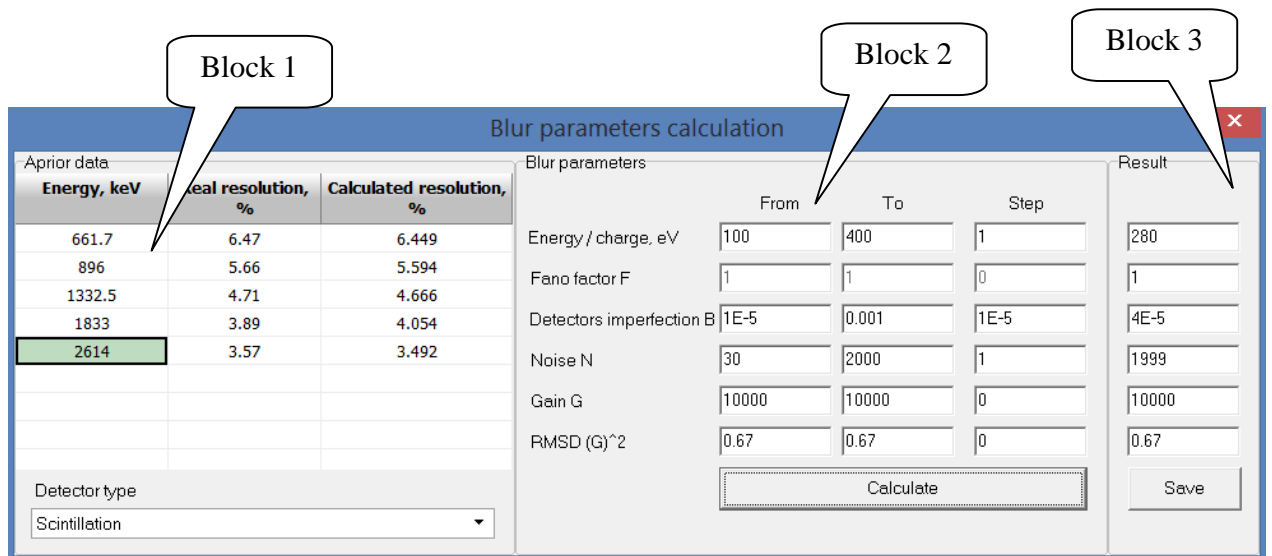

Figure 49. Window **Blur parameters calculation**

Aprior data are the resolution values in % for certain energy values. These data can be obtained on a real detector using standard point or volumetric sources and with their known energy single lines (for example, Cs-137, Y-88, Co-60, etc.). The energy values must be entered in the first column 'Energy, keV' and the resolution values in the second column 'Real resolution'.

The next step is to select the category of the detector under consideration in the **Detector type** drop-down list ('scintillation', 'HPGe', 'gas'). Selecting a detector category allows you to set the correct preliminary ranges to find the optimal parameters specified in box 2 (see Fig. 49). For different types of detectors some parameters can be blocked because their values are known in advance (for example, the Fano factor for the scintillation detector is 1). If you need to calculate for another not listed type of detector you can leave the **Detector type** field empty and then all the parameters will be available for modification.

Next, you need to set the step of changing each parameter in block 2, as well as the range in which the parameter values can change (Fig. 49). If you specify a large step then the fit will be made faster but with less accuracy and vice versa.

After specifying the ranges and steps in block 2 click the **Calculation** button. At the end of the calculations the optimal values for this detector appear in box 3 (Fig.49). In the table in block 1 (Fig. 49) in the column 'Calculated resolution, %' the calculated resolution values for the energies indicated in the first column. The user should evaluate the discrepancy between real and calculated values (the second and third columns) and decide whether the accurately selected detector parameters describe the dependence of the resolution on energy. In the case the result is satisfactory then you can save the parameters in the **Database** by clicking the **Save** button in box 3 (Fig. 49). In the appeared window (Fig. 50) it will be necessary to enter the name of the detector type which is similar in essence to the field **Detector name** as in Fig.48.

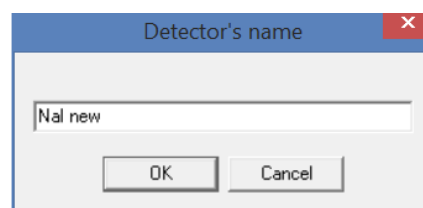

Figure 50. Window **Detector name**

After clicking the **OK** button the window **Blur parameters calculation** window can be closed.

When you call up a database types of detectors (see **Detectors-> Detectors database**) in the list can be seen just entered name.

To perform the blurring procedure select the spectrum to be blurred then select the menu item **Simulate -> Monte-Carlo** or **Simulate->Analog** and then select the type of detector in the appeared window (Fig.51) and click the **Simulate** button.

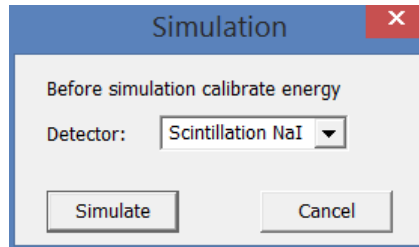

Figure 51 Window **Simulation**

As a result a new blurred spectrum appears in the table at the end of the spectrum list (see Fig. 52).

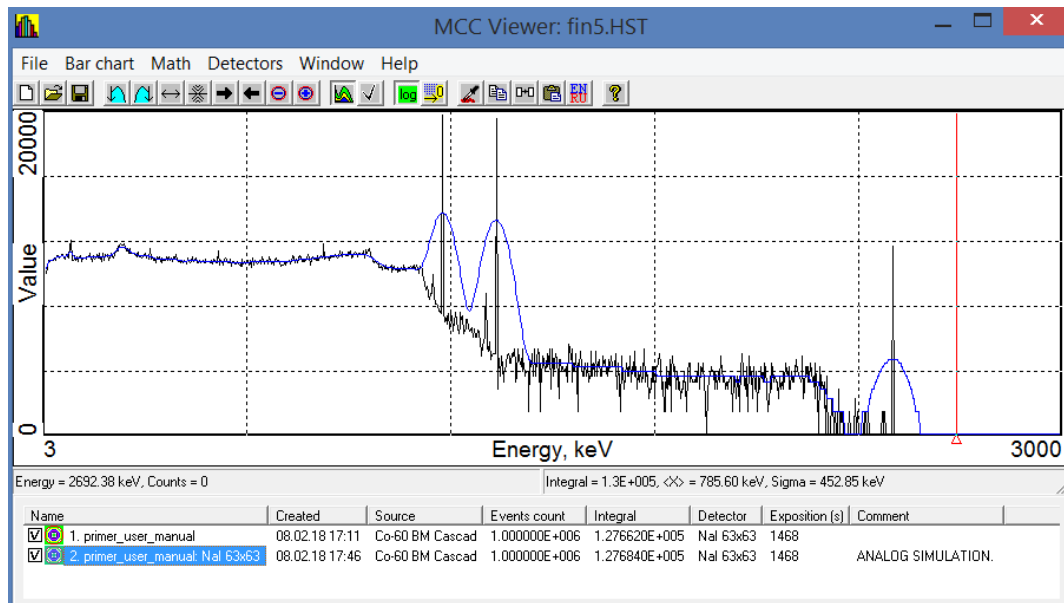

Figure 52. The result of spectrum blurring

The menu item **Detectors-> Efficiency calibration** opens the module of the same name for creating the efficiency curve. The purpose of this procedure (efficiency calibration) is to determine the energy dependence of the detection efficiency of the detector by full-energy peaks of gamma quanta emitted by the simulated sources in a given energy range.

The calibration process is conventionally divided into five stages:

- obtaining the model spectra by calculation with using "MCC-MT";
- processing of spectra in order to search, identify and determine peak areas;
- calculation of the registration efficiency of gamma quanta based on the acquired spectra and approximation of energy dependences of the registration efficiency of gamma quanta;
- creating and saving a calibration file of the **.efp* or **.efr* type;
- repeating the first four steps for other measurement geometries and combining the obtained data into a single efficiency file if necessary.

The **Efficiency calibration** module allows you to automate the sequence described above and obtain registration efficiency curves for a given geometry. Section 8 of this document describes an example of obtaining an efficiency curve based on the project built in section 7.

6.6 Radionuclides libraries editor

For some cases of efficiency curve creation (for example, when using cascade sources, see example in section 8), it may be necessary to use radionuclide library files. The library file contains a list of radionuclides, with the corresponding energy lines and their quantum yields. The program operates with two types of library files (**.bib* and **.lbr*). The first (**.bib*) is a text file and it has the structure of the so-called ini-file; the second (**.lbr*) is also a text file, but it has a different, more outdated structure. Both files can be generated and edited manually (in any text editor), but you can also use the **Radionuclide Library Editor** module.

To open the editor, select the **Detectors->Efficiency calibration** menu item, after which the **Efficiency calibration** module will open. In this module it is necessary to press the button  in the toolbar (see fig. 52.1).

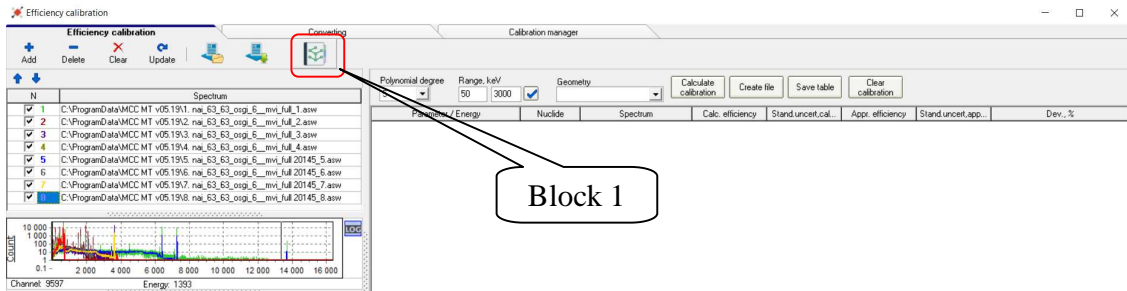

Figure 52.1 View of the module **Efficiency calibration**

A window will appear on the screen, as shown in Figure 52.2.

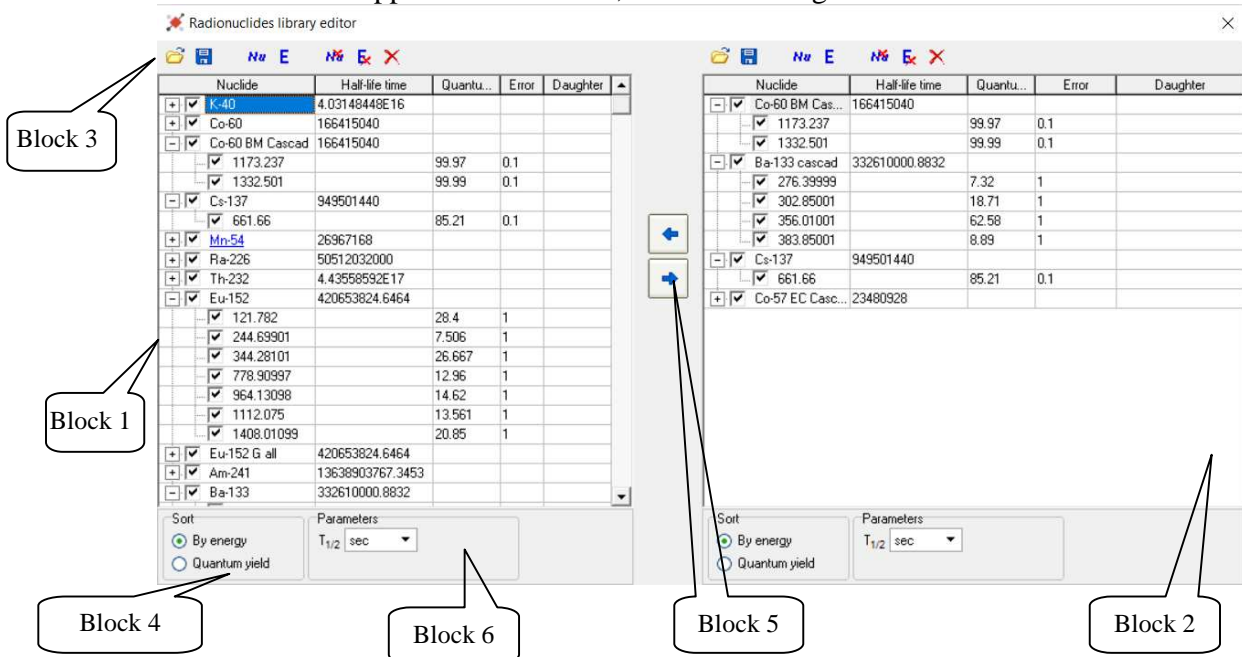





Figure 52.2 View of the window **Radionuclide library editor**



It consists of two symmetrically located blocks that contain a table (block 1 and 2, Fig. 52.2), a toolbar and a block of display parameters (block 3 and 4). The blocks are absolutely identical in functionality, which makes it possible to form libraries using each other's elements. To transfer radionuclides from one library to another, use the arrow buttons (block 5, Fig. 52.2).

The installation package of the "MCC-MT" program may contain one or several libraries, from which you can easily compose individual libraries for specific tasks. To do this, load an existing library into the left block of the window using the button  from the editor toolbar. Then select the required radionuclides and press the button  (Copy selected radionuclides). The selected elements will appear in the right table, after that it can be supplemented, edited and saved. Similarly, you can copy elements from the right table to the left.

To edit the names of radionuclides, energies, etc., double-click the left mouse button on the current value, after that the field will switch to the edit mode. To complete editing, press the Enter button.

To add a radionuclide to the table, press the  (**Add radionuclide**) button. A new element line appears with the radionuclide name 'Nu' with one energy line. The new line will appear above the currently selected line. To add a radionuclide to the end of the table, you must deselect the current row selection. This is done by left-clicking on the field under the table, to the right of the **Parameters** group (Block 6, Fig. 60). The new line must be edited according to the characteristics of the added element.

To add a radionuclide energy line select this element by cursor and press the  (**Add energy**) button in the toolbar. In the new line replace the default values with the required ones (energy, quantum yield, error in determining the quantum yield).

To remove a radionuclide and its energy lines, use the buttons  (**Delete selected radionuclides**) and  (**Delete selected energy lines**), respectively. To clear the entire table, use the  (**Clear Library**) button.

After finishing editing the table you can save it in either of two formats. Saving is performed by clicking on the  (**Save library file**) button in the corresponding toolbar. Please note that the **.lbr* library format does not support saving the so-called "On/off" elements and their lines.

7 Example of the project creation

In this section, we will describe an example of creating a simple project simulating the interaction of radiation from a volumetric source with a detector substance. The measurement configuration should be presented as a set of detection unit with a NaI crystal, a volumetric source - a container with water and a radionuclide ^{60}Co , and a protective lead chamber. The sequence of actions will be accompanied by references to sections where this procedure is described in more detail.

The following describes the sequence of operations for implementing the given example.

7.1 Launch the "MCC-MT" software. [Section 1].

7.2 Add the 'detector crystal' element. To do this in the right pane click the button **New Element** and enter the name 'NaI 63x63'. Next choose from the list the type of surface **Cylinder**. In the dialog window **Edit Cylinder** enter the crystal dimensions: Height 6.3cm; Radius of 3.15 cm. The coordinate Z = -7.16 cm (see Fig.53.1). [Section 3.1]

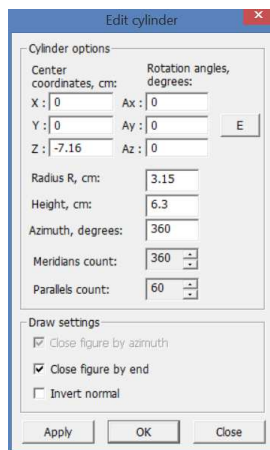

Figure 53.1

7.3 Add the element 'reflector'. To do this in the right pane click the button **New Element** and enter the name 'Reflector'. Next, choose from the list the type of surface **Rotation figure**. In the dialog window **Rotation figure parameters** enter the data for the construction as shown in Figure 53.2 [Section 3.2].

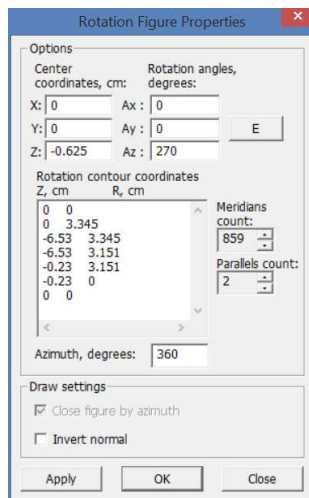

Figure 53.2

7.3 Add the element 'crystal housing'. To do this in the right pane click the button **New Element** and enter the name 'Crystal housing'. Next, choose from the list the type of surface **Rotation figure**. In the dialog window **Rotation figure parameters** enter the data for the construction as shown in Figure 53.3 [Section 3.2].

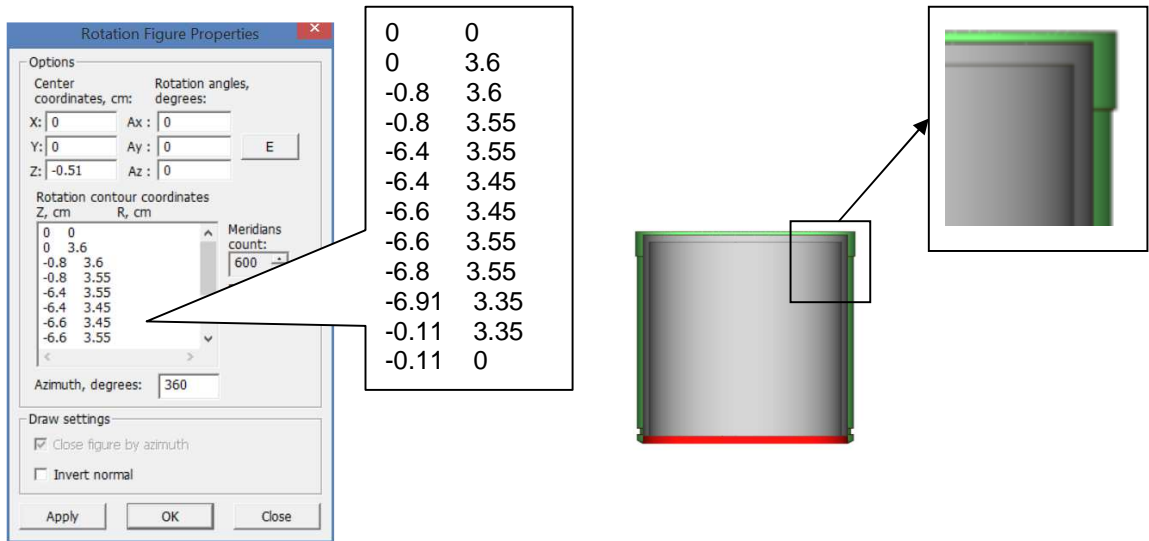

Figure 53.3

7.4 Add the element 'glass crystal'. To do this in the right pane click the button **New Element** and enter the name 'Glass crystal'. Next, choose from the list the type of surface **Cylinder**. In the dialog window **Edit Cylinder** enter the data for the construction as shown in Figure 53.4 [Section 3.1].

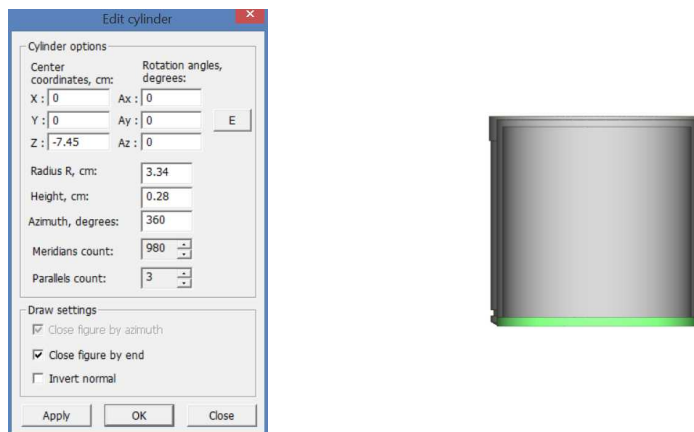

Figure 53.4

7.5 Add the element 'PMT'. To do this in the right pane click the button **New Element** and enter the name 'PMT'. Next, choose from the list the type of surface **Rotation figure**. In the dialog window **Rotation figure parameters** enter the data for the construction as shown in Figure 53.5 [Section 3.2].

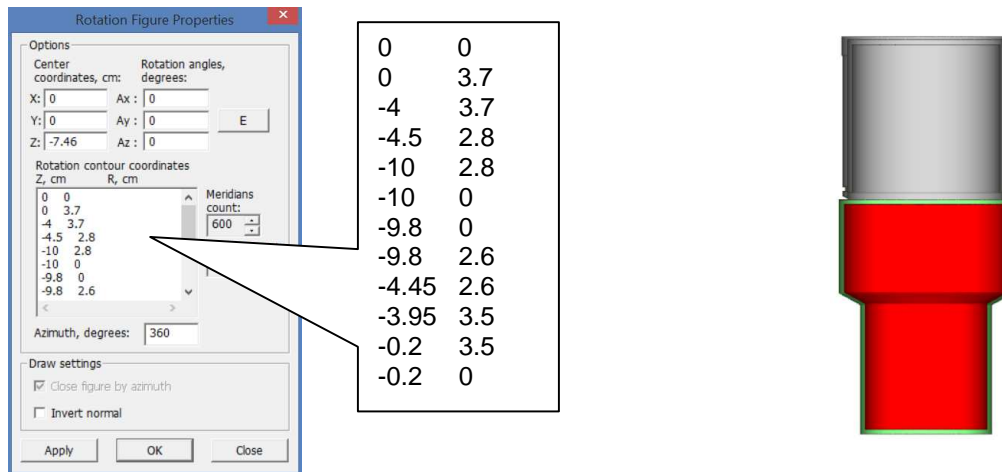

Figure 53.5

7.6 Add the element 'detector housing'. To do this in the right pane click the button **New Element** and enter the name 'Detector housing'. Next, choose from the list the type of surface **Rotation figure**. In the dialog window **Rotation figure parameters** enter the data for the construction as shown in Figure 53.6 [Section 3.2].

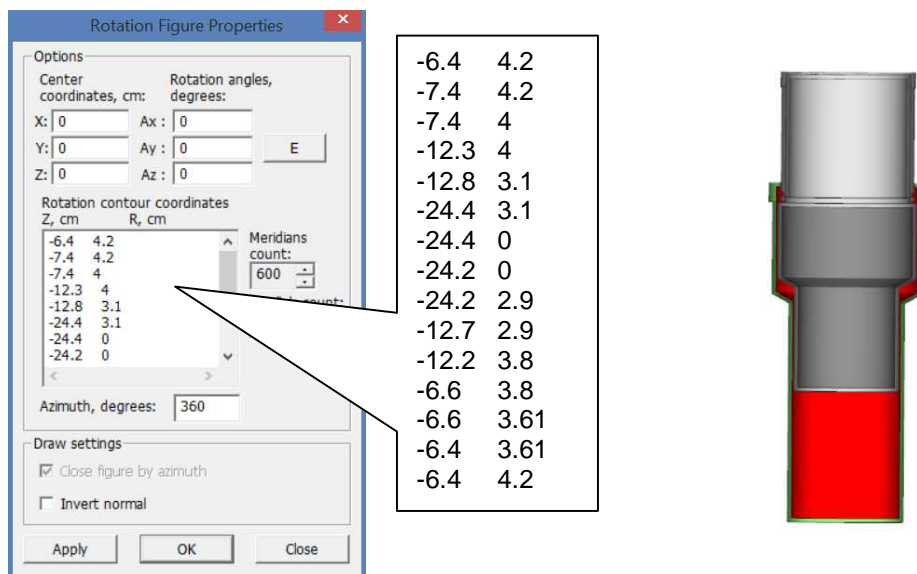

Figure 53.6

7.7 Add the element 'chamber housing'. To do this in the right pane click the button **New Element** and enter the name 'Pb housing'. Next, choose from the list the type of surface **Rotation figure**. In the dialog window **Rotation figure parameters** enter the data for the construction as shown in Figure 53.7. Then for this element, click the button **New Surface** and again select the **Rotation figure** and now enter the dimensions as shown in Figure 53.8. Thus, two surfaces will be used for this element (see Figure 53.9). [Section 3.2].

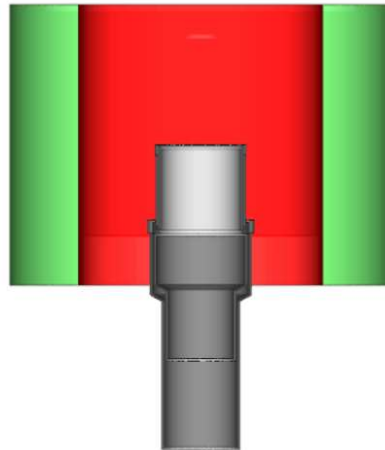
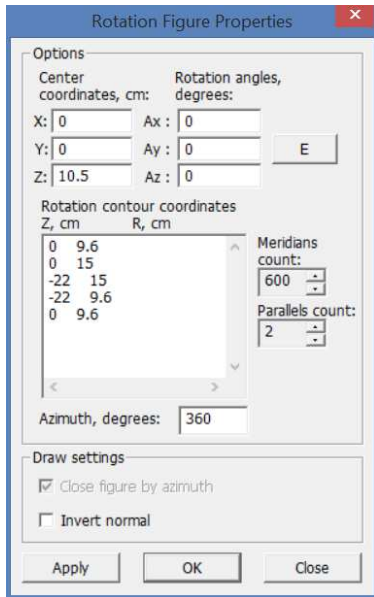

Figure 53.7

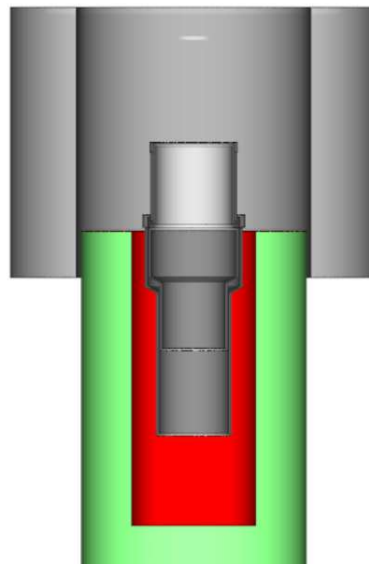
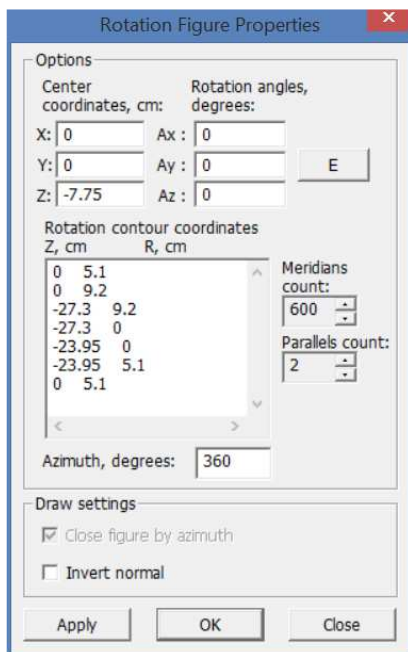

Figure 53.8

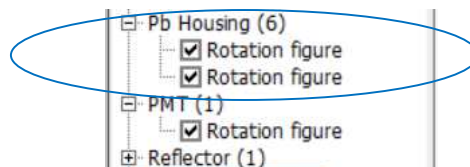

Figure 53.9

7.8 Add the element 'chamber cover'. To do this in the right pane click the button **New Element** and enter the name 'Pb cover'. Next, choose from the list the type of surface **Cylinder**. In the dialog window **Edit Cylinder** enter the data for the construction as shown in Figure 53.10. [Section 3.1].

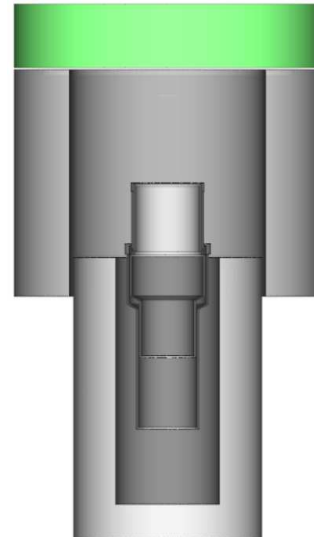
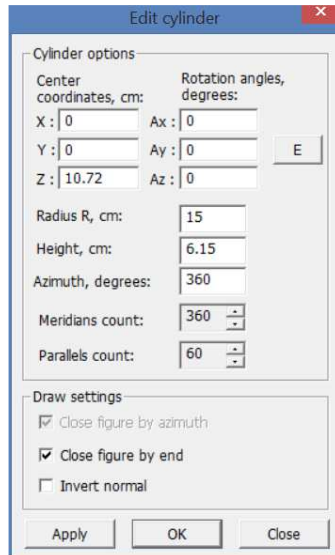

Figure 53.10

7.9 Add the element 'volumetric source'. To do this in the right pane click the button **New Element** and enter the name 'Volume Source'. Next, choose from the list the type of surface **Rotation figure**. In the dialog window **Rotation figure parameters** enter the data for the construction as shown in Figure 53.11. In this project, a volumetric source is placed on the end surface of the detector. [Section 3.2].

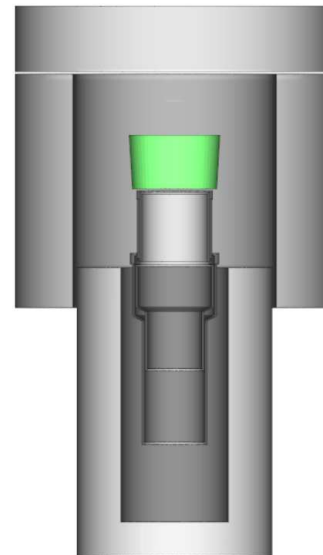
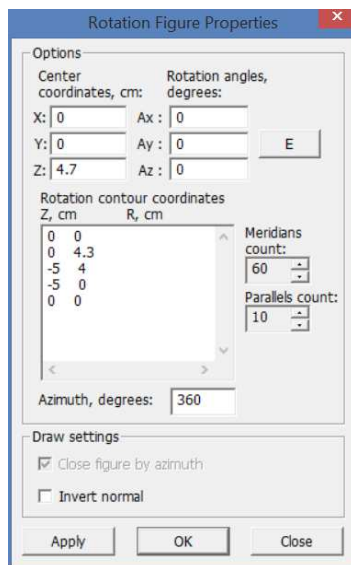



Figure 53.11

7.10 Click the button  in the main toolbar and in the window that appears select menu item **Options-> Elements**. In the window **Edit Elements** that appears (see Figure 53.12), you have to set physical properties for each element of the project. [Section 4.1].

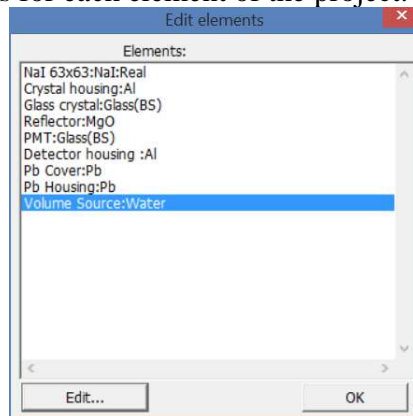

Figure 53.12

In the parameters window for the element 'Na 63x63' it is necessary to set a sign that this element will be a detector (see Fig.53.13)

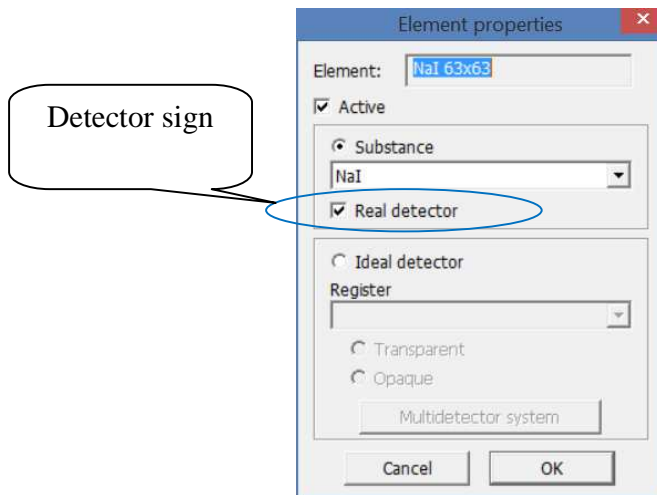

Figure 53.13

As materials for the elements 'Crystal housing', 'Detector housing' the aluminum (Al) is chosen; Glass (Glass (BS)) is selected for the 'Glass crystal' and 'PMT' elements; Magnesium oxide (MgO) is selected for the 'Reflector' element; for 'Pb housing' and 'Pb cover' lead (Pb) is chosen; water is selected for the element 'Volume Source'.

After you have linked the materials to the project elements, click **OK**.

7.11 In the menu of the window **Calculation** select **Options->Radiation Source Geometry**. In the appeared window **Radiation Source Geometry** (see Figure 53.14) set the type **Element** and then select item 'Volume Source' from the drop-down list. Click **OK**. [Section 4.2].

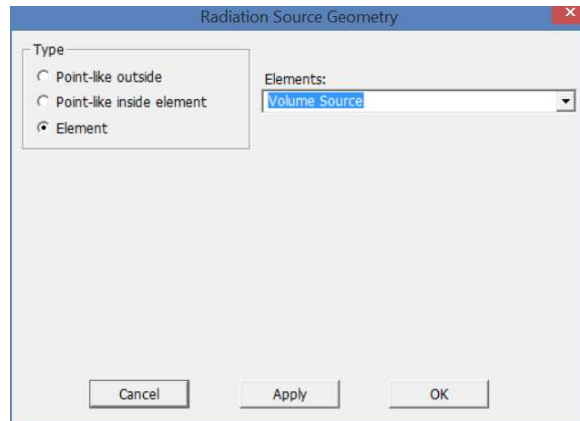

Figure 53.14

7.12 In the menu of the window **Calculation** select **Options->Radiation type**. In the appeared window **Radiation sources** (see Figure 53.15) in the left field find the source 'Co-60 BM Cascad' and press the button **>>**, after that the selected source will move to the right field **Used radiation sources**. Click **OK**. [Section 4.3].

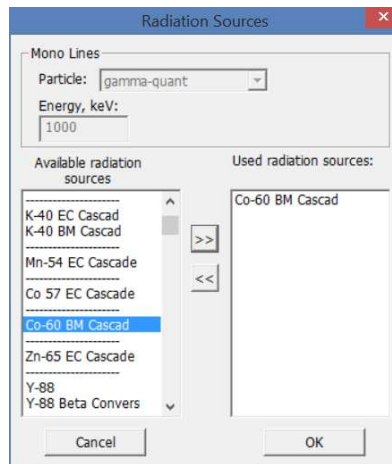

Figure 53.15

7.13 In the menu of the window **Calculation** select **Options-> Measuring mode**. In the appeared window **Measuring mode** specify the values in the fields as shown in the figure 53.16. Click **OK**. [Section 4.4].

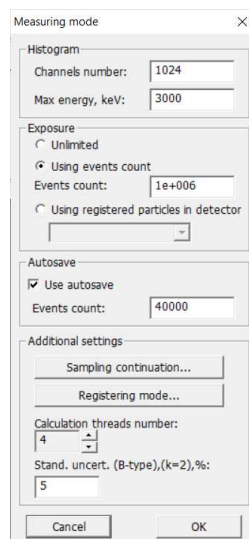



Figure 53.16

7.13 In the toolbar of the window **Calculation** click the button  or select the menu item **Operations->Start/Stop Calculations**. The calculation process will begin indication in the working field of the window **Calculation** (see Figure 53.17).

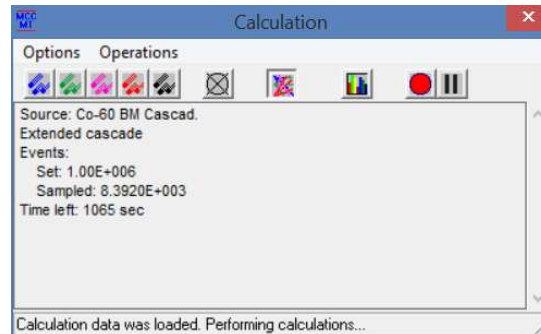



Figure 53.17

For purposes of clarity and control of the calculation performed the user can turn on the displaying of the contours of the particle trajectory by clicking on the buttons  (draw gamma-quant) and  (outline contours) in the toolbar of the window **Calculation**. As a result the calculation process will be accompanied by drawing the particle trajectories, and look as shown in Figure 53.18.

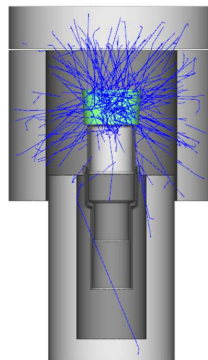

Figure 53.18

After calculation of the specified number of events is completed, the program will open the module "**MCC Viewer**" in which the result will appear in the form of a spectrum (see Fig. 53.19).

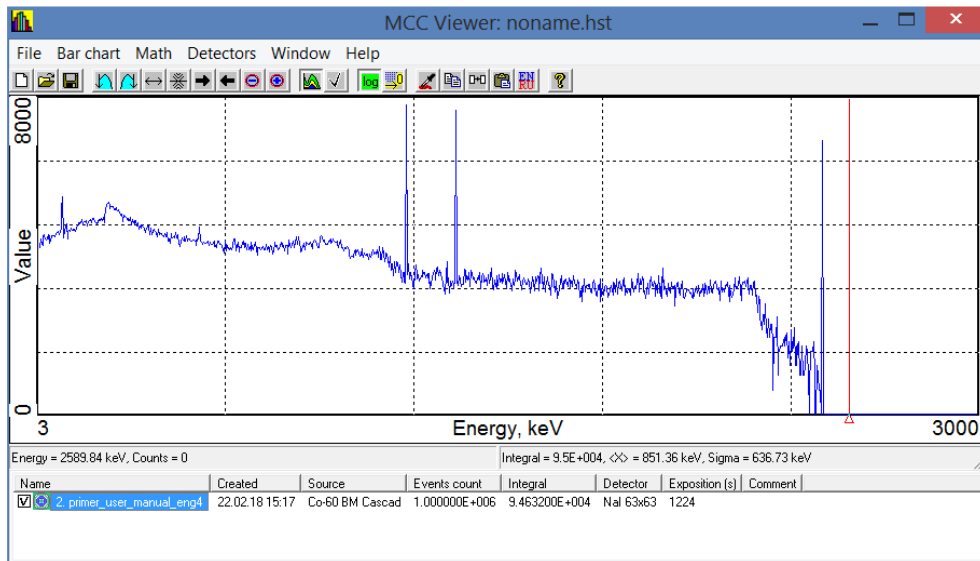

Figure 53.19

7.14 The spectrum obtained as a result of the calculation is the response of the detector. To obtain a spectrum emulating the real spectrum for a current detection system, it is necessary to perform a blurring procedure. To do this, select the menu item **Detectors->Simulatee->Analog** in the window of the module "MCC Viewer" and in the appeared window select the type of detector from the drop-down list and then press the button **Simulate**.

At the end of the list, the new sought spectrum will appear (see Fig. 53.20) with the given activity of 1 Bq. [Section 6].

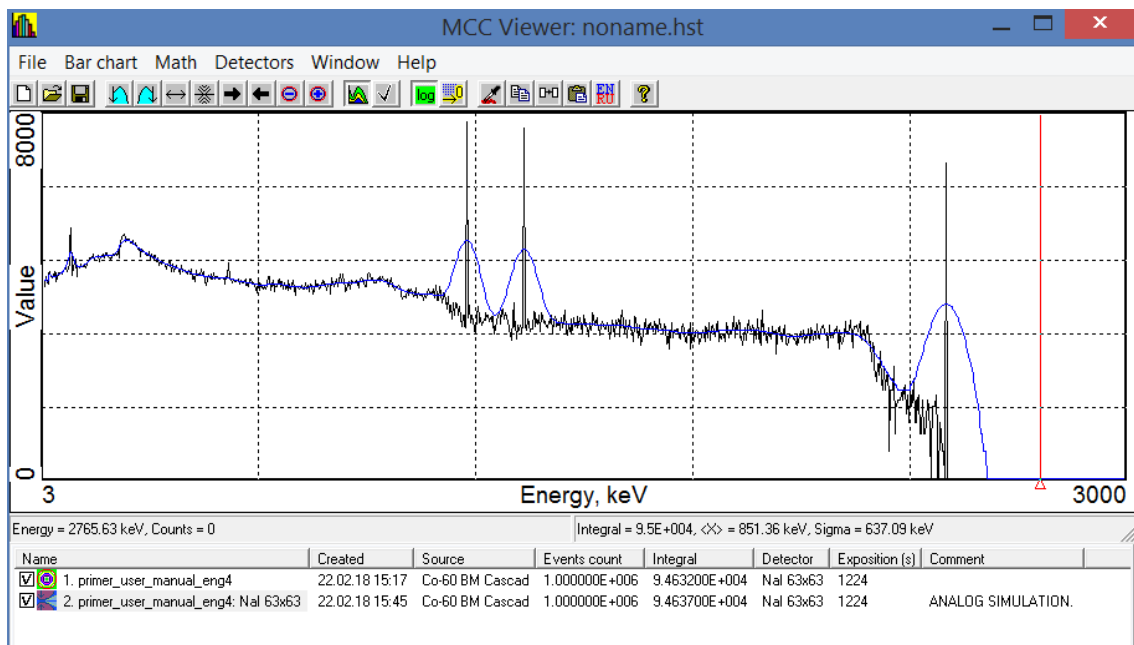

Figure 53.20

7.15 To further use the spectrum for calibration purposes of the spectrometer it can be exported to the format *.txt* or *.asw*. To do this, select the spectrum and choose the menu item **File->Export file**, and then save it in the standard dialog window in the required format. [Section 6].

8 Example of the efficiency curve creation

The calibration of spectrometer by registration efficiency is made using simulated spectra of activity reference samples that reproduce the geometry and absorption properties of gamma radiation of the measuring samples.

As a result of calibration the energy dependence of the registration efficiency in the full energy peaks of gamma quanta emitted by reference samples is determined.

In this section will describe examples of creating efficiency curves for the project from Section 7.

8.1 Efficiency curve creation based on artificial monoenergetic lines

Below is a sequence of steps to implement the given example.

8.1.1 Build a model of the detecting system in accordance with Section 7.

In the window **Calculation** in "MCC-MT" software, select the menu item **Options-> Radiation type**. In the window **Radiation sources** that appears (see Fig. 54.1), in the left field, select a series of artificial sources '50', '100' ... '3000', etc. depending on the required energy range, which must be described by the efficiency curve and then press the button , after that the selected sources will move to the right field **Used radiation sources**.

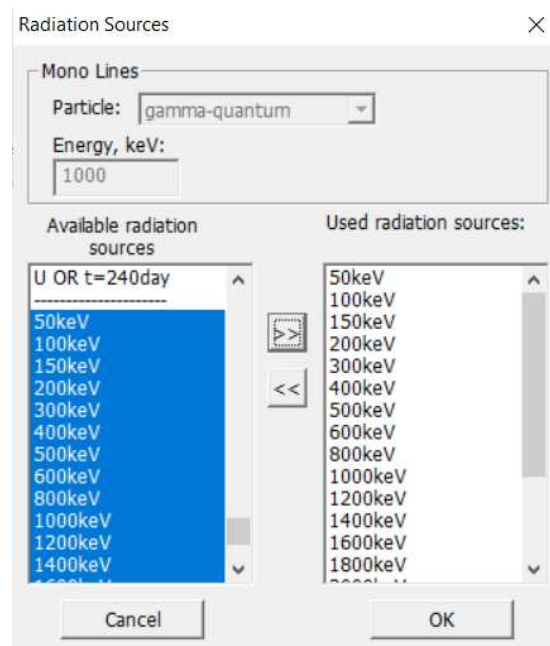

Figure 54.1

8.1.2 In the menu of the window **Calculation** select the menu item **Options-> Measuring mode**. In the appeared window **Measuring mode** specify values in the fields, as shown in figure 54.2. The number of events in the **Exposure** group can be set more or less depending on the required statistical accuracy. Also, the **Channels number** in the group **Histogram** should be specified depending on the spectrum channels of the real spectrometer. Click **OK**. [Section 4.4].

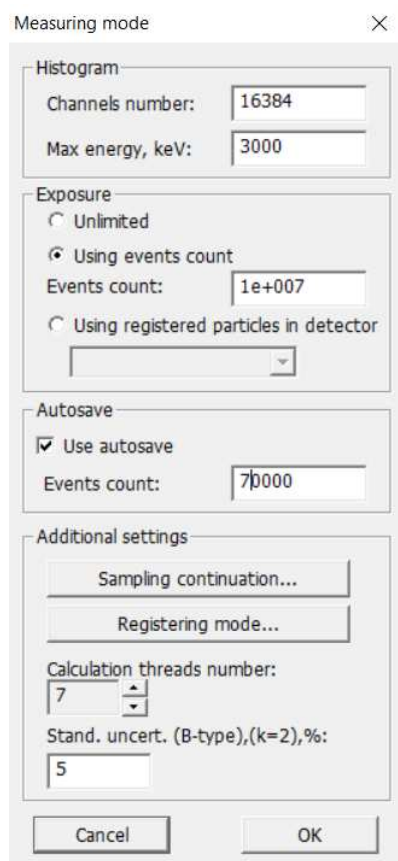



Figure 54.2

8.1.3 In the menu of the window **Calculation**, press the button  or select the menu item **Operations->Start/End Measurements**. In the working field of the window **Calculation** will show the process of calculation (see Fig. 54.3).

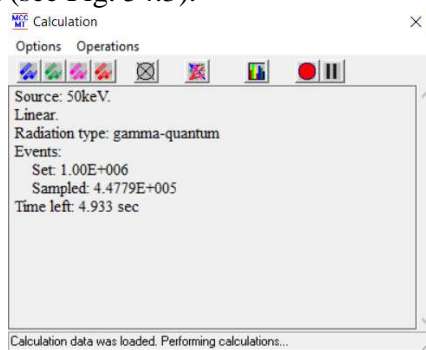

Figure 54.3

At the end of the calculation of each spectrum from a series of specified sources, the program will add it to the "MCC Viewer" module as separate rows. Each spectrum or all of them will be drawn as shown in Figure 54.4.

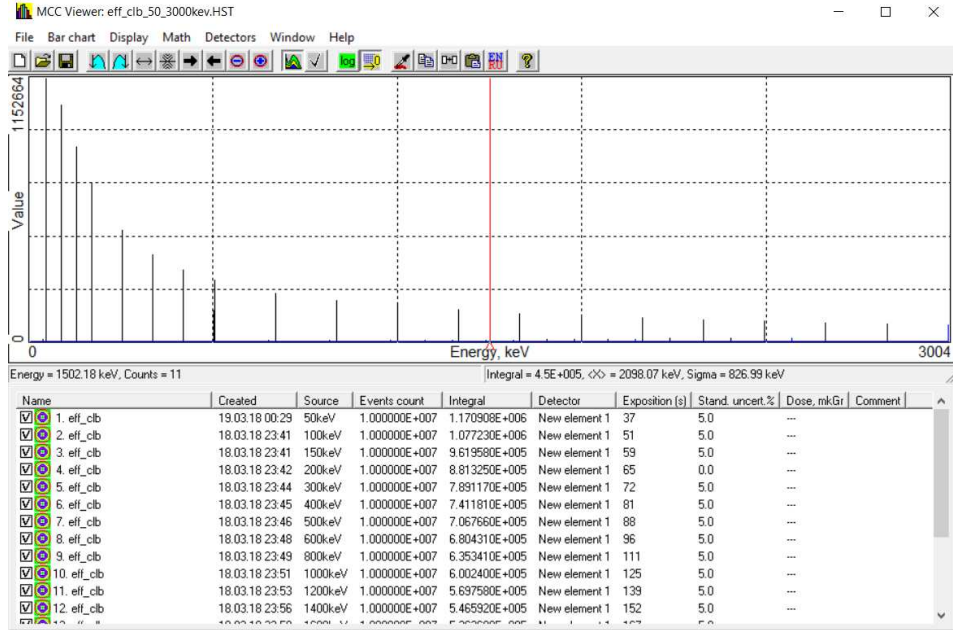

Figure 54.4

8.1.4 In the main menu of the "MCC Viewer" module, select the item **Detectors->Efficiency calibration**, after which a new module Efficiency calibration will appear (see Fig. 54.5).

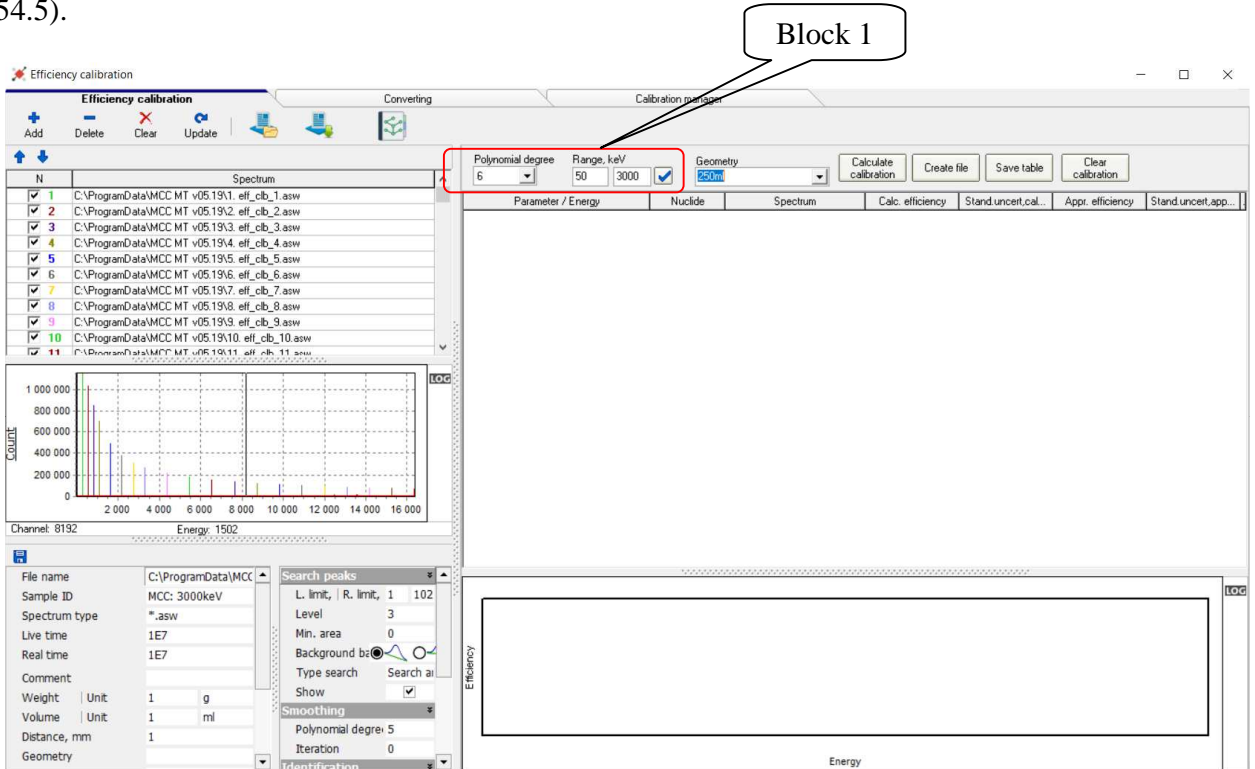

Figure 54.5

8.1.5 In the module **Efficiency calibration** indicate the energy range for making the efficiency curve and the degree of the polynomial (from 1 to 6) describing the required curve (see block 1, Fig. 54.5). Then press the button **Calculate calibration**, after that the required dependence will be built, and the results will be displayed in the table (see Fig. 54.6).

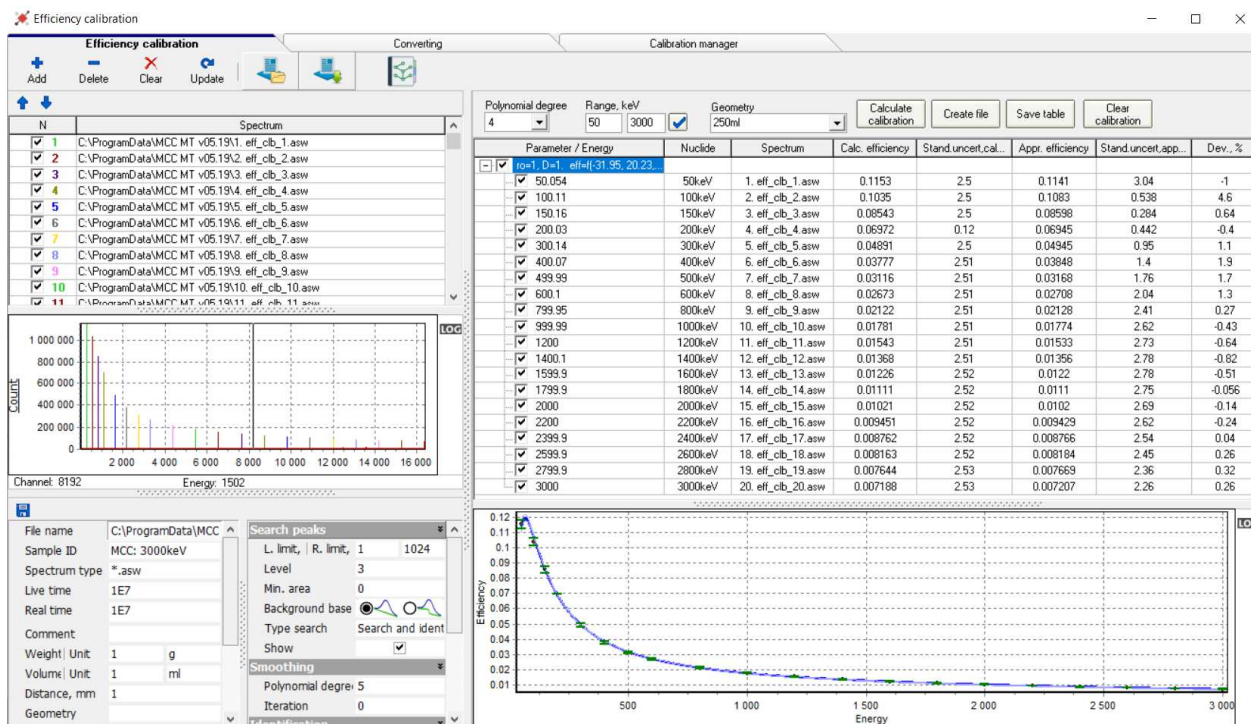



Figure 54.6

8.1.6 The obtained results of efficiency calibration are saved by pressing the button . The resulting file of efficiencies can be saved in usual format for "MCC-MT" program **.efp* or in the format of a third-party program **.efr*.

The **.efp* file will store the functional dependences of the registration efficiency of the energy of gamma quanta. Dependencies are stored as coefficients A_i of a polynomial of the form:

$$\varepsilon_n = \exp(A_0 + A_1 \ln E_n + A_2 (\ln E_n)^2 + A_3 (\ln E_n)^3 + A_4 (\ln E_n)^4 + A_5 (\ln E_n)^5 + A_6 (\ln E_n)^6)$$

The efficiency file also stores information about all points involved in the calculation, that allows spectrometric analysis software to use the true efficiency values for the radionuclide lines that were directly involved in the calibration procedure.

8.1.7 For possibility of further work with the current set of spectra it is possible to create an efficiency file project. To do this, press the button  in the toolbar (see Fig. 54.6) and enter the name of the current project and the path to the directory to save it.

If you need to continue work with the project, you can open it using the button . In this case, the program will load all spectra involved in the calibration, as well as restore the parameters of the plotting curves and the calculated tables.

8.1.8 It should be noted that for plotting a curve based on monoenergetic lines (with a 100% yield probability) without taking into account cascade radionuclides, the preliminary blurring of the used theoretical spectra (p.7.14), as well as the presence of a link to the radionuclide library files is not required.

8.1.9 As part of the demonstration materials, there is a video demonstrating the procedure of creating the efficiency curve described in clauses 8.1.1-8.1.8.

8.2 Efficiency curve creation based on sources with multiple energy lines

If it is necessary to construct a curve of the registration efficiency based on the energy of gamma quanta from sources with real energy lines (and with the addition of data on cascade radionuclides), it takes to construct a model of the detection system in accordance with Section 7 firstly.

8.2.1 In the menu of the window **Calculation** select item **Options-> Radiation type**. In the window **Radiation sources** that appears (see Fig. 53.15) in the left field select the source 'Co-60 BM Cascad' and/or a list of any other types of sources (including non-cascading ones) and press the button **>>**, after which they will be moved to the right field **Used radiation sources** (see fig. 54.7). Click **OK**. [Section 4.3].

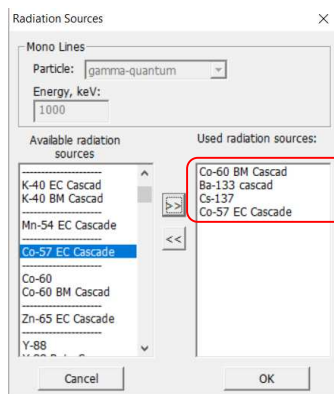



Figure 54.7

8.2.2 Set the parameters in the **Measuring mode** window in the same way as described in paragraph 8.1.2.

8.2.3 In the menu of the window **Calculation**, press the button  or select the menu item **Operations->Start/End Measurements**. In the working field of the window **Calculation** will show the process of calculation (see Fig. 54.3).

At the end of the calculation of each spectrum from a series of specified sources, the program will add it to the "MCC Viewer" module as separate rows. Each spectrum or all of them will be drawn as shown in Figure 54.8.

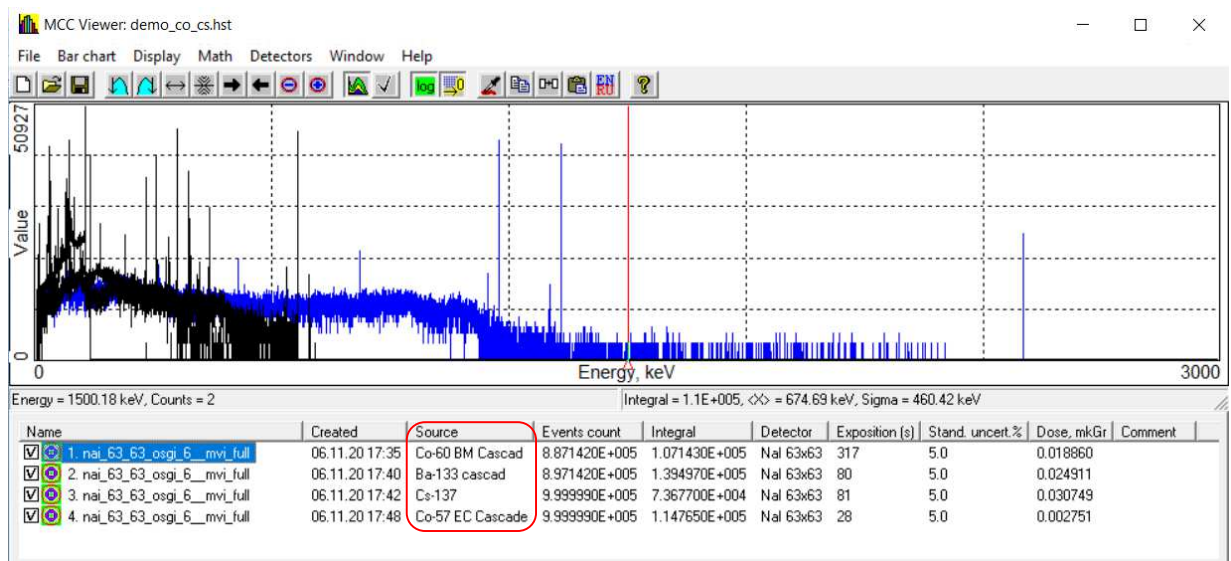

Figure 54.8

8.2.4 The spectra obtained as a result of the performed calculation performed are the theoretical response of the detector. It takes to obtain spectra that simulate real spectra for a given detection system, therefore it is necessary to perform the blurring procedure. To do this check the boxes for each of the spectra (as shown in Figure 54.8), and then in the module window "MCC Viewer" select the menu item **Detectors->Simulate->Analog** and in the window that appears, select the detector type from the drop-down list and then click the button **Simulate**. At the end of the list new required spectra (see Fig. 54.9) with a reference activity of 1 Bq will appear.

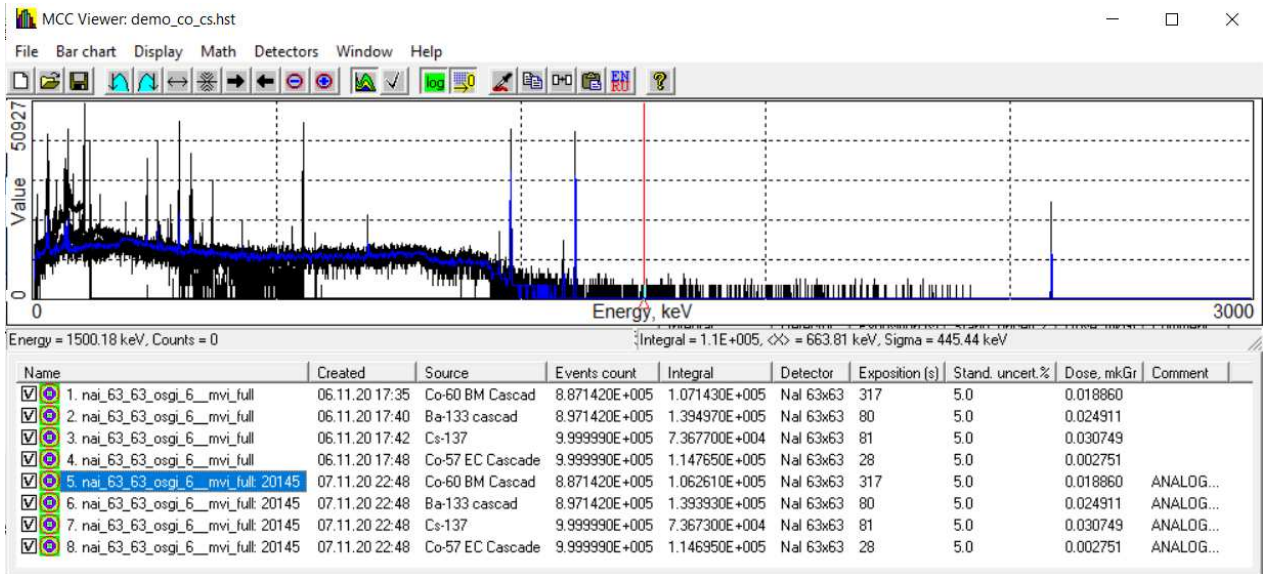

Figure 54.9

8.2.5 In the main menu of the module "MCC Viewer" select the item **Detectors->Efficiency calibration**, after which a new module **Efficiency calibration** will appear (see Fig. 54.10).

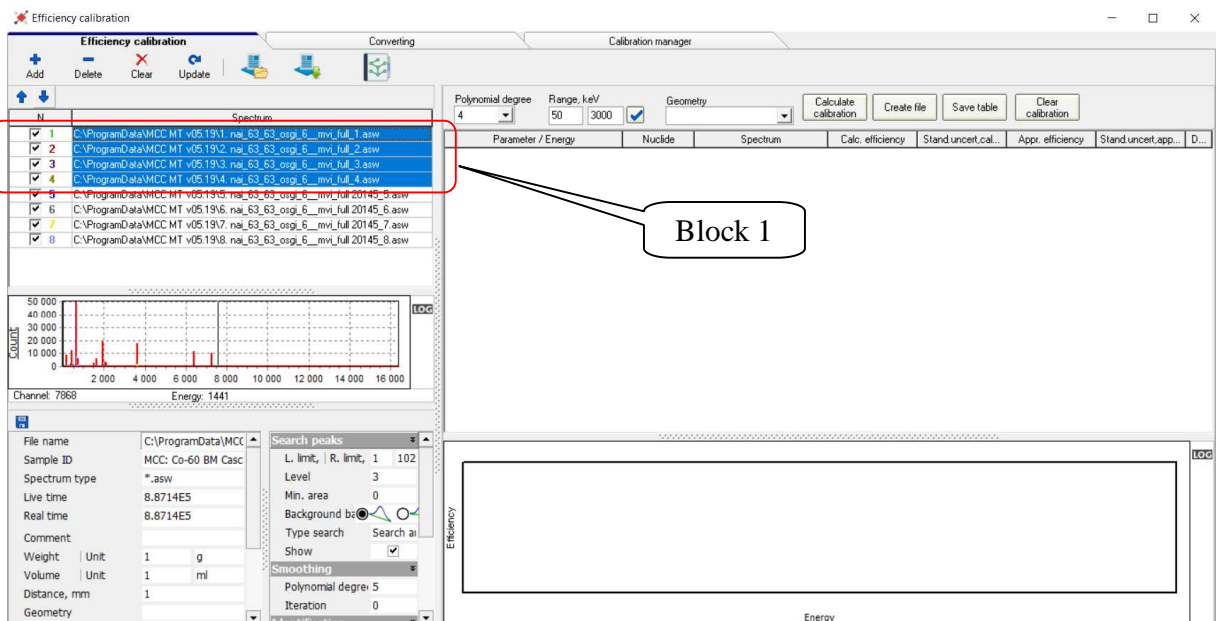



Figure 54.10

8.2.6 Because the first four spectra in the table are not blurred spectra (Fig. 54.10, block 1), they should not participate in further calculations and can be deleted using the button  **Delete**.

8.2.7 Further, for each blurred spectrum that will participate in the creation of the efficiency curve it is necessary to load the library file containing the energy lines that the program should use to construct the curve. The procedure for creating the library files is described in section 6.6.

For this example the library file looks as shown in Figure 54.10a, block 1.

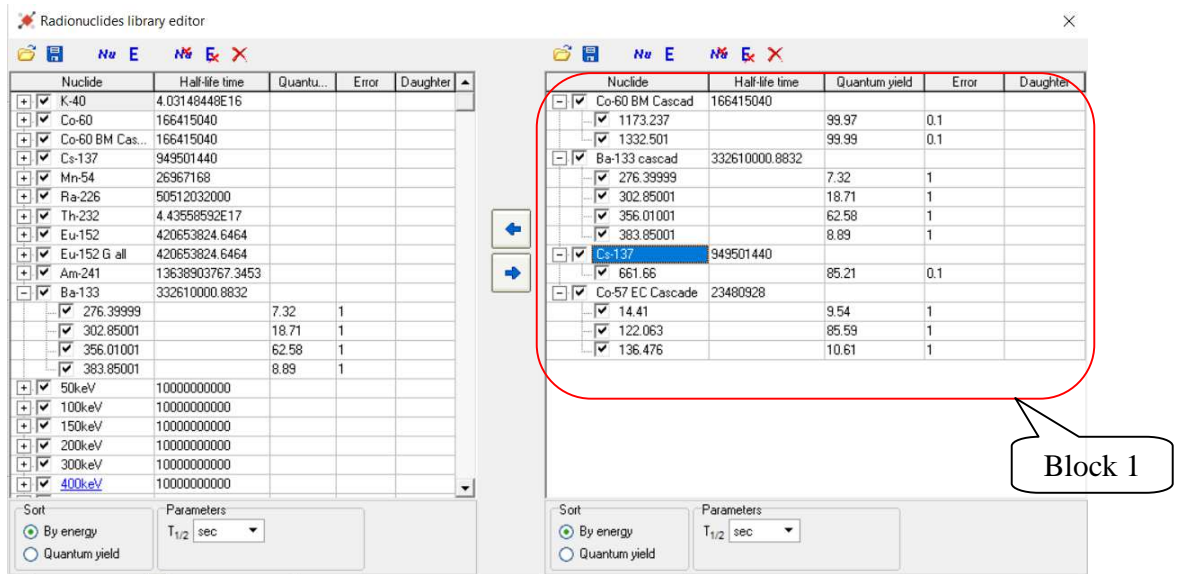



Figure 54.10a

To indicate the spectra of its library file it is necessary to sequentially select each spectrum (Fig. 54.11, block 1), and load it into the field **Library** (Fig. 54.11, block 2) using the standard file selection dialog which is invoked by pressing the button .

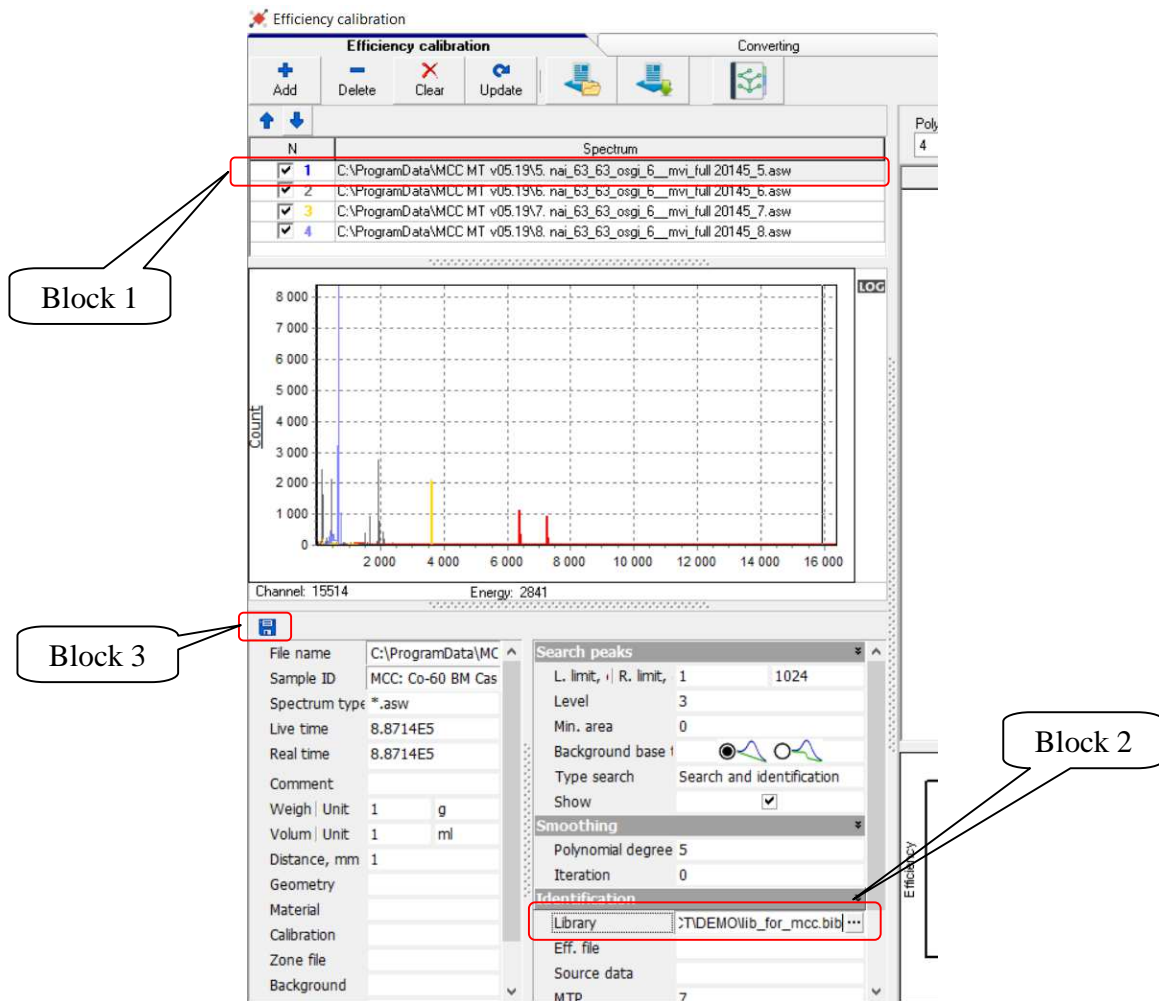

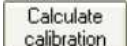

Figure 54.11

After selecting the library file it takes necessarily press the button  for saving the spectrum (Fig. 54.11, block 3).

8.2.8 After the library files are specified for each spectrum, then the energy range for plotting the efficiency curve and the degree of the polynomial (from 1 to 6) describing the required curve are indicated (see block 1, Fig. 54.5). Then it should press the button , after that the desired dependence will be built (see Fig. 54.12, block 1) in the form of a graph (see Fig. 54.12, block 1), and the results will be displayed in the table above it.

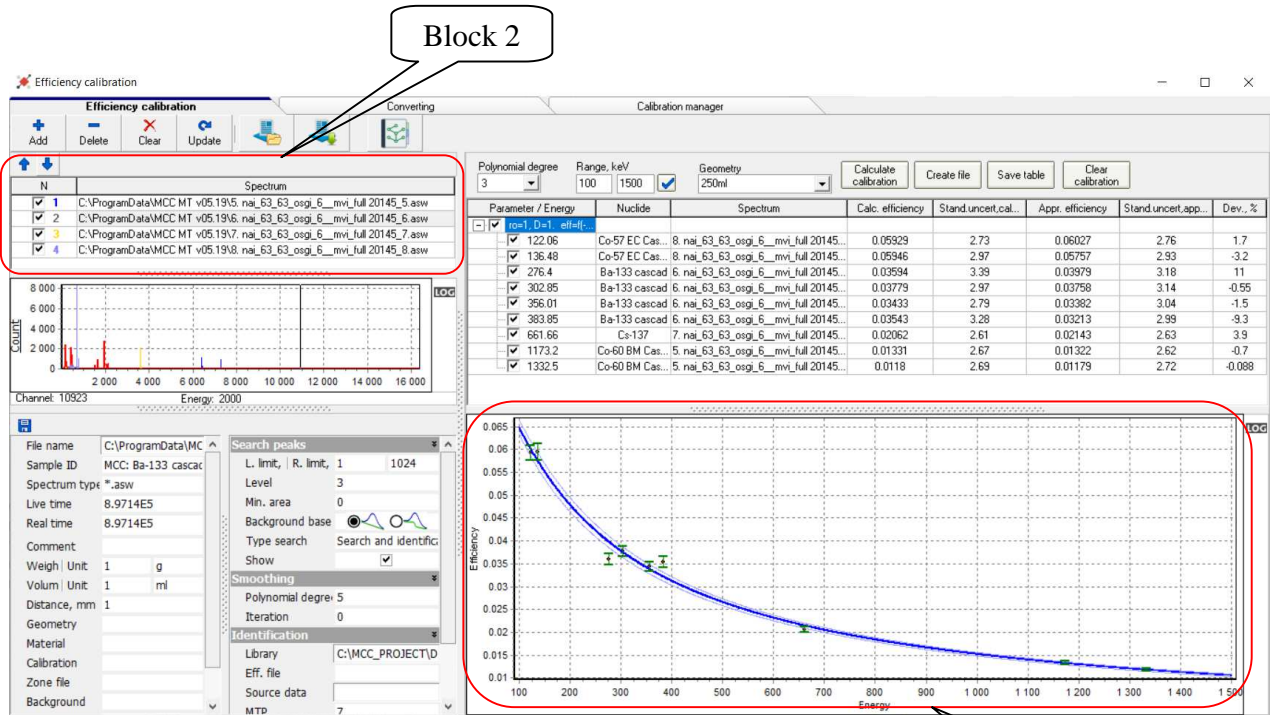

Figure 54.12

Block 1

8.2.9 The results obtained in the form of an efficiency file and a project file should be saved in the same way as described in paragraphs 8.1.6 and 8.1.7.

8.2.10 It should be noted that the creation of the efficiency curve according to paragraphs 8.1 and 8.2 can be carried out together. It is only important that if the spectrum contains only one artificial line (a source with a monoline and an yield probability of 100%), then there is no need to blur the spectrum and the library file is not required, and vice versa, if the spectrum contains several real energy lines, then it takes an additional blur the spectrum and specify the library file for it.

For joint processing and plotting the efficiency curve according to clauses 8.1 and 8.2, all calculated spectra must be loaded into the spectra table (see Fig. 54.12, block 2), after that it is

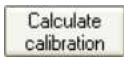
necessary to press the button  and the desired dependence will be obtained.